



Visit our website

www.ChassisShop.com

CHASSIS SHOP

PERFORMANCE PRODUCTS

*Your #1 Source For
Superior Quality
Racing Parts*



*Manufacturer and Distributor for
Drag Racing, Circle Track, Off Road and Road Racing*

The Chassis Shop was founded and built upon providing value. Led by over two decades of performance experience and the dedication to provide the highest quality supplies available, we have established ourselves as the leading performance supplier. You can be assured that this leadership role will continue through our founding commitment.

performance & quality



Sales

Our friendly sales and technical staff provide individualized and knowledgeable service. Our entire organization is dedicated toward working to exceed your expectations.



Selection

We offer an extensive selection of the highest quality name brands that deliver performance to a wide range of applications, for both professionals and do-it-yourselfers.



Quality

Our fabricated items are manufactured to the highest tolerances and specifications. These items are proudly made in the USA. You can be assured that you're getting the finest quality merchandise available.



Performance

We are committed to your team's performance. Whether you're a fast charger like Shawn Bowen (cover) or a weekend warrior, you'll receive the personalized attention that will keep you running up front.

CHASSIS SHOP

PERFORMANCE PRODUCTS

With our wide selection of stocked products and quick shipping response time, ordering parts is fast and easy. Whether it's a small fastener or a truckload of materials, we make ordering a quick and simple process.

how to order

Toll Free Number: 800-530-9494

Call our toll free order line at 800-530-9494 for quick, friendly service and processing of your order. Order line open Monday-Friday, 9 AM - 5 PM EST

Fax: 231-873-0218

Fax your order 24 hours a day for convenient processing. Make sure to include your company information, part numbers, and shipping requirements. All orders received via fax are confirmed via fax.

Website: www.ChassisShop.com

Our internet site is set up to provide product information and answer basic technical questions. You can email us with additional questions. Online order form is available. All online orders are confirmed via email providing reply address is given.

TECH LINE: 231-873-3640

Get the expert technical help you need by calling 231-873-3640. Our staff combines years of racing experience and engineering knowledge. Tech line open Monday-Friday, 9 AM - 5 PM EST. Tech questions can also be emailed to ChassisShop@oceana.net.

Mail:

Orders and questions can be mailed to us at:
The Chassis Shop Perf. Prod. Inc.
1931 N. 24th Avenue
Mears, MI 49436

Showroom

We are located near the Silver Lake Sand Dunes on the beautiful Lake Michigan Shoreline. Browse our performance showroom open Monday-Friday, 9 AM -5 PM EST.

contents

FABRICATION	PAGE	CNC	PAGE	CROW	PAGE		PAGE
Body Components	3-9	Master Cylinders	41	Driver Restraints	71-73	Swivel-Seal Hose Ends	98-99
Steering & Controls	10-15	Pedal Assemblies	42-44			Aluminum Adapters	100-104
Suspension & Driveline	16-17	Hand Brakes	45	TUBING, PLATE, BRACKETS	74	Filters, Valves, & Gauges	105
		Gas Pedals	45	Tubing	Specialty Shapes	Hard Line	106
					Assorted	Speed Seal Hose Ends	107
PRO-WERKS	18	MORSE	46	Plate	Pre-Bent	Steel Adapters	108-109
Clamps	19-20	Cables & Hardware	47-49	Tubing	Mild Steel	Tech Info	110-111
Caps & Bungs	21			Brackets	Chromoly		
		AUTO METER	50		Slot Clevis		
KONI	22	Gauges	51-55	TUBE ADAPTERS	86	BOOKS & CLOTHING	112
Shocks	23-25	Tachometers	56-59	Specialty Shapes	87	Manuals & Sportswear	113
		Accessories	60-61	Round	88-89		
EIBACH	26	PAINLESS	62			TURBO	114
Springs	27	Wiring	63-67	AURORA	90	Turbo Chargers	115
		STROUD	68	Rod Ends	91-93	Wastegates	116
WILWOOD	28	Parachutes	69			Replacement Parts	117
Rear Brake Kits	29-31			EARL'S	94	4-Cylinder	118
Front Brake Kits	32-35			Performance Hose	95-96		
Calipers	36			Auto-Fit Hose Ends	97	ORDER FORM	119
Brake Pads	37					NOTES	120
Master Cylinders	38					TERMS & CONDITIONS	BACK COVER
Pedal Assemblies	39						

fabrication

The Chassis Shop first established itself as an experienced builder of high quality race cars. Our no-compromise attitude to performance and safety has led to superior quality fabrication components, tools, and materials for professional

chassis builders and do-it-yourselfers. Engineered to the highest standards and manufactured out of premium materials, Chassis Shop components provide the best in performance, reliability, and value.

DRAGSTER WINDSCREEN

Measuring 1/8" thick, these windscreens are both flexible and durable. Made from scratch resistant GE Lexan. Easily cut and sanded for installation. Several sizes to choose from in either clear or tinted. Protective coating dissolves with water after fitting.



PART #	DESCRIPTION	APPROX. SIZE	PRICE
C42-014	STD CLEAR	7" H x 17" W x 33" L	\$179.95
C42-020	TALL CLEAR	9" H x 17" W x 33" L	\$204.95
C42-024	WIDE CLEAR	9" H x 20" W x 33" L	\$229.95
C42-026	JUNIOR CLEAR	5" H x 14" W x 25" L	\$59.95
C42-015	STD TINTED	7" H x 17" W x 33" L	\$204.95
C42-021	TALL TINTED	9" H x 17" W x 33" L	\$224.95
C42-025	WIDE TINTED	9" H x 20" W x 33" L	\$254.95
C42-027	JUNIOR TINTED	5" H x 14" W x 25" L	\$69.95

PRO GLASS WINDOW CLEANER

Professional race car window cleaner, effective on any transparent surface-acrylics, plexiglass, Lexan, glass, polycarbonate, and all safety glazing. It is fast drying, anti-static, anti-fog, non-streaking, and reduces glare.



PART #	DESCRIPTION	PRICE
C42-019	PRO GLASS WINDOW CLEANER	\$5.95

Carrier regulations prohibit air shipment of this product.

DRAGSTER NOSE

These popular body pieces are now available made of hand laid composite materials simplifying the completion of your race car. *These noses may be trimmed to match your height, length, and angle requirements.*

C42-022

* Dimensions:
8-1/2" wide,
8-1/2" tall at back,
25" long



PART #	DESCRIPTION	PRICE
C42-022	ECONO DRAGSTER NOSE	\$149.00

C42-023

* Dimensions:
11-3/4" wide,
8-1/2" tall at back
28" long



PART #	DESCRIPTION	PRICE
C42-023	FUEL DRAGSTER NOSE	\$169.00

WINDSCREEN FASTENER KIT

Includes 100° #8 flat head screws and nylock nuts.



PART #	DESCRIPTION	PRICE
C42-018	WINDSCREEN FASTENER KIT (24PK)	\$9.95
C42-034	WINDSCREEN FASTENER KIT (100PK)	\$42.00

ACCESS DOOR KIT

Stylish design provides easy access to knobs, fill caps, and computers. Complete kit includes aluminum door, stop flange, hinge, and all mounting hardware.



PART #	DESCRIPTION	PRICE
C73-490	5" x 5" DOOR	\$49.95
C73-492	8" x 12" DOOR	\$59.95

ACCESS DOOR RELEASE

This flush mounted release is made of stainless steel construction, is spring loaded and equipped with positive lock. Ideal for access doors.



PART #	DESCRIPTION	PRICE
C73-480	ACCESS DOOR RELEASE	\$22.95

ESCAPE HATCH LATCH

Positive locking and easily released, stainless steel construction for corrosion resistance.

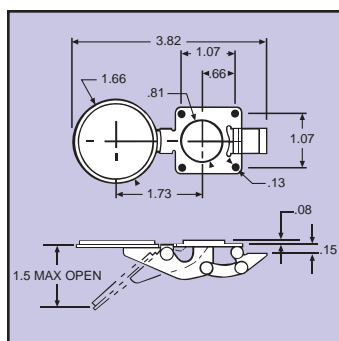
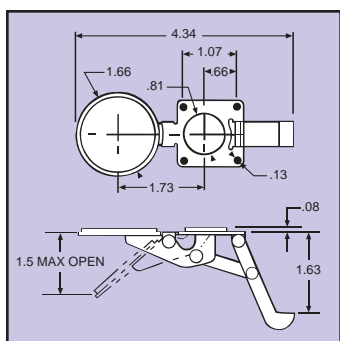

PART #	DESCRIPTION	PRICE
C73-482	FLAT HOOK (B)	\$42.74
C73-484	LONG HOOK (A)	\$55.86

ALUMINUM HINGE

Perfect for access doors. Lightweight aluminum 1/16" thick x 1-1/16" wide x 12" long.

PART #	DESCRIPTION	PRICE
C73-485	ALUM. HINGE	\$5.95



CHASSIS STABILIZER

Stabilizes chassis movement during transport, reducing chassis fatigue, and suspension wear on dragsters or door cars. Easily inflated, includes 30# safety valve to prevent over inflation. Very durable, 1/2" thick rubber.



PART #	DESCRIPTION	PRICE
C72-070	ROUND STABILIZER 18" DIA. (INFLATES UP TO 10")	\$199.95
C72-071	MIDGET STABILIZER 7" x 24" (INFLATES UP TO 4")	\$199.95
C72-076	ROUND WALL MOUNT	\$17.95
C72-075	9' HOSE EXTENSION KIT (Fits Both Styles)	\$17.95

WHEEL CRADLES

May be permanently attached to floor of trailer for positioning of car in trailer. Designed for cars using 17" (Narrow) front wheels. Sold as pair.



PART #	DESCRIPTION	PRICE
C72-079	WHEEL CRADLES	\$109.95

COMPOSITE DRAGSTER SEAT

These lightweight hand laid composite seats are comfortable when installed in dragsters, altered, or funny cars. Flexible enough to adjust in width if needed, measures 20-1/2" wide at top, 28" tall along back, and 17" wide at bottom front.

PART #	DESCRIPTION	PRICE
C42-028	FIBERGLASS	\$150.00
C42-029	CARBON FIBER	\$220.00



Carbon fiber is stronger and lighter.



PLASTIC NACA DUCT WITH HOSE OUTLET

Hi-impact clear or black plastic versions allow air hose hook-up for direct routing of air. Two sizes available.



Clear Ducts

PART #	DESCRIPTION	PRICE
C42-002	3-1/2" WIDE, 6-1/2" LONG, 2-1/2" HOSE OUTLET, CLEAR	\$29.95
C42-008	4-1/4" WIDE, 9-1/4" LONG, 3" HOSE OUTLET, CLEAR	\$31.95



Black Ducts

PART #	DESCRIPTION	PRICE
C42-001	3-1/2" WIDE, 6-1/2" LONG, 2-1/2" HOSE OUTLET, BLACK	\$22.95
C42-007	4-1/4" WIDE, 9-1/4" LONG, 3" HOSE OUTLET, BLACK	\$23.95

HOSE KIT

Reinforced flexible hose works with plastic NACA Ducts.

PART #	DESCRIPTION	PRICE
C42-012	2-1/2" WIRE REINFORCED BLACK NEOPRENE HOSE (10 FT.)	\$62.95
C42-013	3" WIRE REINFORCED BLACK NEOPRENE HOSE (10 FT.)	\$62.95



C42-012

FIBERGLASS NACA DUCT

Three versions now available of our popular lightweight hand laid fiberglass NACA Ducts.

- Provides a positive low resistance method of fresh air entry or removal.
- Easily attached with bonding compound or riveted on fiberglass, aluminum, or steel body panels.

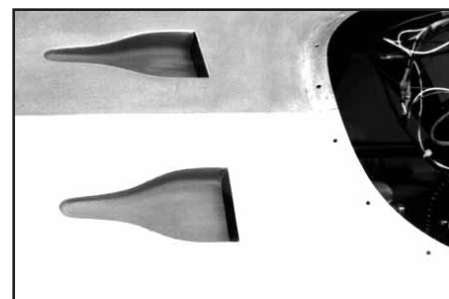
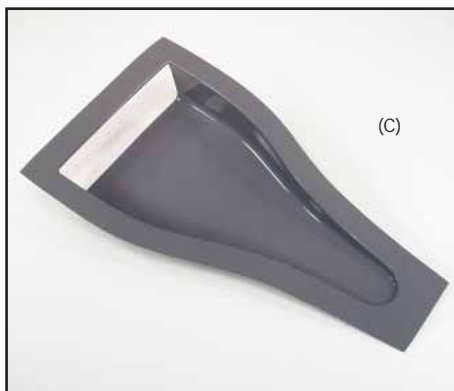
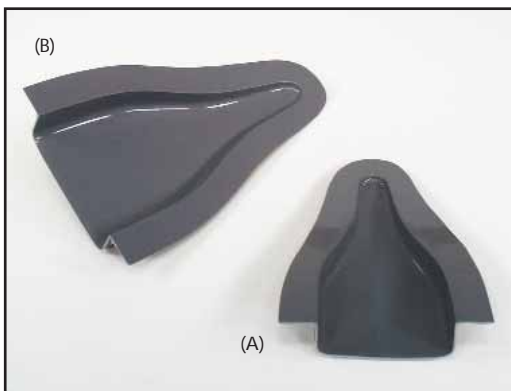

NACA Ducts Installed

REF	PART #	DESCRIPTION	PRICE
A	C42-016	3" WIDE, 6-1/2" LONG, 7/8" DEEP INLET	\$19.95
B	C42-017	4" WIDE, 9" LONG, 1" DEEP INLET	\$22.95
C	C42-030	7" WIDE, 14" LONG, 2" DEEP INLET	\$32.95

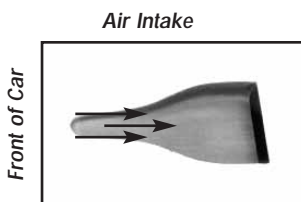

Front of Car

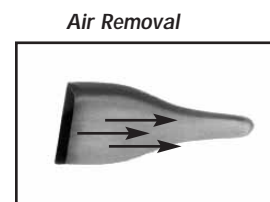

Front of Car

DZUS WRENCH

Every toolbox should have one. Fits all Dzus buttons.



PART #	DESCRIPTION	PRICE
C72-010	DZUS WRENCH	\$6.59

TRANSFER PUNCH



Fits in tab with or without spring. For accurate transfer of hole location onto attaching panel.

PART #	DESCRIPTION	PRICE
C73-544	TRANSFER PUNCH	\$7.50

DIMPLE TOOLS

Provides professional quality dimple necessary for flat head buttons.



REF	PART #	DESCRIPTION	PRICE
A	C73-540	WRENCH TYPE	\$16.96
B	C73-541	HAMMER TYPE	\$18.95

DOUBLER PLATES

Aluminum construction .040", rivets on location for increased strength of fiberglass, carbon fiber, and aluminum panels. Sold in 10 packs.



DISCOUNT PRICE PER PACK

PART #	TYPE	1-4	5+
C73-535-10	SQUARE	\$8.95	\$8.05
C73-536-10	ROUND	\$8.95	\$8.05

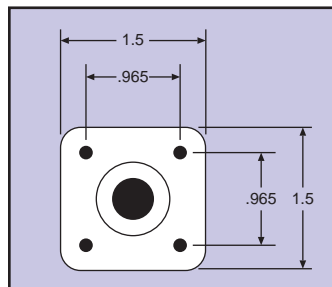
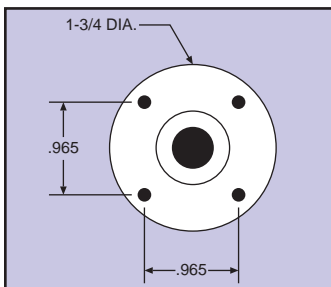

SPRING ADJUSTER

Effectively adjusts fastener springs that are too tight or too loose. Universal design fits both spring sizes sold on page 7.

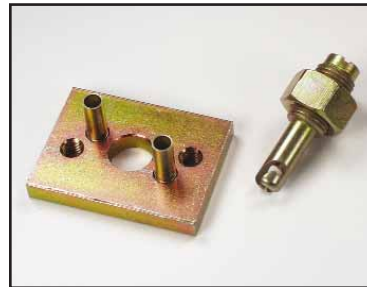

PART #	DESCRIPTION	PRICE
C73-545	SPRING ADJUSTER	\$24.95

Simplify assembly of your project by using one length button and adjusting the spring height for varied panel thickness.

CLECOS

Quick and easy to use, spring loaded Cleco fasteners are inserted into drilled rivet holes to temporarily hold panels in place during fit up. Available in several sizes - Cleco pliers are required for installation.



PART #	DESCRIPTION	QTY.	PRICE
C72-011	PLIERS	1	\$12.95
C72-013	3/32"	10	\$6.95
C72-015	1/8"	10	\$6.95
C72-019	3/16"	10	\$6.95

ALUMINUM SPRING RIVETS

Special dual groove creates a large bulb to retain the spring. 1/8" dia., fits all springs.

PART #	DESCRIPTION	QTY.	PRICE
C73-531	ALUM. SPRING RIVETS	10	\$0.75
C73-532	ALUM. SPRING RIVETS	100	\$7.50



PANEL FASTENERS

Self-locking fasteners are widely used for fastening panels, hoods, etc. They provide an easily operated, positive acting, shake proof fastener. Several styles to choose from, all are functional for steel, aluminum, and fiberglass installations. Sold in packs of 10.

BUTTONS

Accepts C73-505, C73-508, or C73-510 tab with C73-525 spring. Sold in packs of 10.

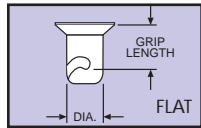
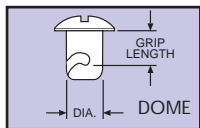

DOME STEEL

DISCOUNT PRICE PER PACK

PART #	DIA.	GRIP	1-4	5-9	10+
C73-562-10	.406	.400	\$14.90	\$13.41	\$12.66
C73-563-10	.406	.450	\$14.90	\$13.41	\$12.66
C73-564-10	.406	.500	\$14.90	\$13.41	\$12.66
C73-565-10	.406	.550	\$14.90	\$13.41	\$12.66
C73-566-10	.406	.600	\$14.90	\$13.41	\$12.66
C73-567-10	.406	.650	\$14.90	\$13.41	\$12.66

DOME ALUMINUM

DISCOUNT PRICE PER PACK

PART #	DIA.	GRIP	1-4	5-9	10+
C73-572-10	.406	.400	\$15.90	\$14.31	\$13.51
C73-573-10	.406	.450	\$15.90	\$14.31	\$13.51
C73-574-10	.406	.500	\$15.90	\$14.31	\$13.51
C73-575-10	.406	.550	\$15.90	\$14.31	\$13.51
C73-576-10	.406	.600	\$15.90	\$14.31	\$13.51
C73-577-10	.406	.650	\$15.90	\$14.31	\$13.51

FLAT STEEL

DISCOUNT PRICE PER PACK

PART #	DIA.	GRIP	1-4	5-9	10+
C73-582-10	.406	.400	\$14.90	\$13.41	\$12.66
C73-583-10	.406	.450	\$14.90	\$13.41	\$12.66
C73-584-10	.406	.500	\$14.90	\$13.41	\$12.66
C73-585-10	.406	.550	\$14.90	\$13.41	\$12.66
C73-586-10	.406	.600	\$14.90	\$13.41	\$12.66
C73-587-10	.406	.650	\$14.90	\$13.41	\$12.66

FLAT ALUMINUM

DISCOUNT PRICE PER PACK

PART #	DIA.	GRIP	1-4	5-9	10+
C73-592-10	.406	.400	\$15.90	\$14.31	\$13.51
C73-593-10	.406	.450	\$15.90	\$14.31	\$13.51
C73-594-10	.406	.500	\$15.90	\$14.31	\$13.51
C73-595-10	.406	.550	\$15.90	\$14.31	\$13.51
C73-596-10	.406	.600	\$15.90	\$14.31	\$13.51
C73-597-10	.406	.650	\$15.90	\$14.31	\$13.51

TABS & SPRINGS

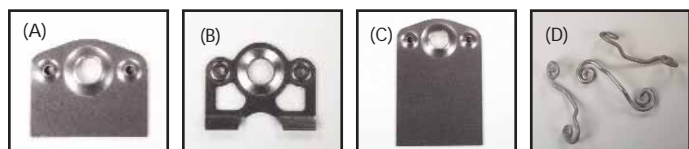

REF.	PART #	TYPE	1-4	5-9	10-29
A	C73-505-10	REG. LENGTH	\$6.00	\$5.40	\$5.10
B	C73-508-10	LIGHTWEIGHT	\$7.00	\$6.30	\$5.95
C	C73-510-10	LONG LENGTH	\$6.50	\$5.85	\$5.52
D	C73-525-10	SPRING*	\$4.90	\$4.41	\$4.16

*1-3/8" c-c Holes/ .425" Tall

SELF-EJECT BUTTONS

Accepts C73-500 tab and C73-515 spring. Sold in packs of 10.

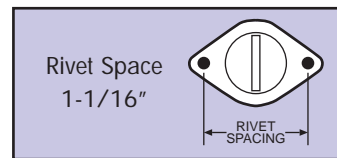

FLAT HEAD (A)

DISCOUNT PRICE PER PACK

PART #	DIA.	GRIP	1-4	5-9	10-29
C73-598-10	.350	.400	\$20.00	\$18.00	\$17.00
C73-599-10	.350	.450	\$20.00	\$18.00	\$17.00
C73-600-10	.350	.500	\$20.00	\$18.00	\$17.00
C73-601-10	.350	.550	\$20.00	\$18.00	\$17.00
C73-602-10	.350	.600	\$20.00	\$18.00	\$17.00
C73-603-10	.350	.650	\$20.00	\$18.00	\$17.00

WING STYLE (B)

C73-610-10	.350	.500	\$27.90	\$25.11	\$23.71
------------	------	------	---------	---------	---------

SELF-EJECT TAB & SPRING



Sold in packs of 10.



DISCOUNT PRICE PER PACK

PART #	TYPE	1-4	5-9	10-29
C73-500-10	TAB	\$6.50	\$5.85	\$5.52
C73-515-10	SPRING*	\$4.90	\$4.41	\$4.16

*1" c-c holes/ .325" tall

TECH TIP

HOW TO MEASURE GRIP LENGTH If you are trying to match existing buttons on your application, follow these illustrations to determine the correct measurement. Grip length is measured from the rim surface in contact with the surface of the panel (A) and the actual fastened point of the spring (B). Diameter is (C).

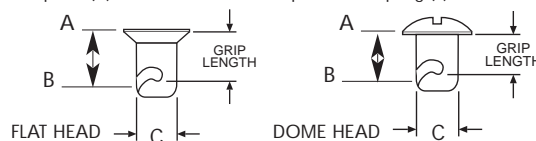

LARGE SELF-EJECT BUTTONS

"Pro-Stock Style"

Flat head accepts C73-505, C73-508, or C73-510 tab with C73-525 spring. Sold in packs of 10.

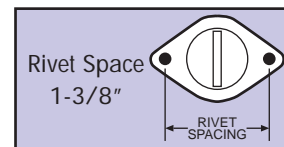

DISCOUNT PRICE PER PACK

PART #	DIA.	GRIP	1-4	5-9	10-29
C73-612-10	.406	.400	\$28.99	\$26.09	\$24.64
C73-613-10	.406	.450	\$28.99	\$26.09	\$24.64
C73-614-10	.406	.500	\$28.99	\$26.09	\$24.64
C73-615-10	.406	.550	\$28.99	\$26.09	\$24.64
C73-616-10	.406	.600	\$28.99	\$26.09	\$24.64
C73-617-10	.406	.650	\$28.99	\$26.09	\$24.64

REAR WING

• Comp • Super Comp • Super Pro • TAD • Top Dragster • Altered • Roadsters •

Rear wings are built from wind tunnel proven NACA wing profiles. Durable all aluminum construction featuring .032" thick aircraft aluminum skin. Assembled with our super quality CNC machined ribs (15" cord length) and internal reinforcement tubes. The 3/16" thick mount brackets have 3/8" dia. front and 5/16" dia. rear holes with a 5-7/8" spacing. We can custom build up to 70" wide. These wings not only look great, but are effective in providing stability and downforce with minimal drag.

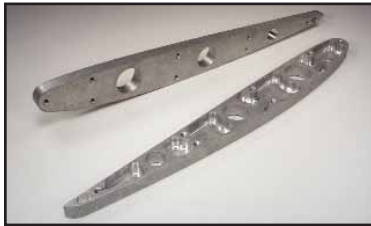

Assembled with billet CNC machined ribs.

PART	DESCRIPTION	PRICE
C42-136	36" WIDE	\$399.00
C42-140	40" WIDE	\$399.00
C42-144	44" WIDE	\$399.00
C42-148	48" WIDE	\$449.00
C42-150	CUSTOM WIDTH	CALL US



Tip plates are removable & interchangeable (10-24 stainless screws) Your choice of these six tip plate profiles. **Select tip plate profile and include letter at end of part number. (Ex. C42-136-B)**

WING TIP PROFILES

All tip plate profiles designed for equal performance.

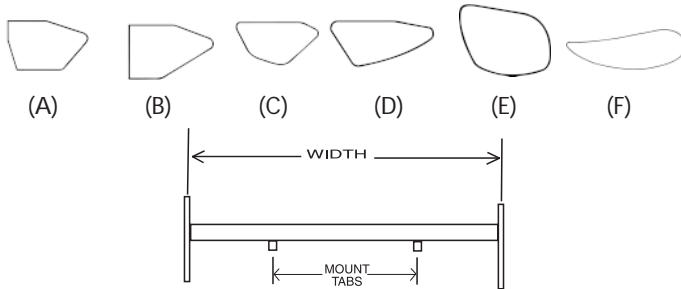

Standard mount tab spacing is available or positioned to your specifications.

REAR WING DOWNFORCE/DRAW DATA

Calculated values based on ideal environmental conditions & 40" x 15" wing size.

		50 MPH	100 MPH	150 MPH	200 MPH
8° ANGLE OF ATTACK	DOWNFORCE	27.8 lbs	111.3lbs	250.4 lbs	445.1 lbs
	DRAG	.3 lbs	1.0 lb	2.3 lbs	4.1 lbs
10° ANGLE OF ATTACK	DOWNFORCE	32.4 lbs	129.5 lbs	291.5 lbs	517.9 lbs
	DRAG	.3 lbs	1.2 lbs	2.7 lbs	4.9 lbs
12° ANGLE OF ATTACK	DOWNFORCE	36.2 lbs	144.6 lbs	325.5 lbs	578.6 lbs
	DRAG	.4 lbs	1.4 lbs	3.2 lbs	5.7 lbs

WING STRUT KITS

These kits are available with all the pieces necessary to build your wing strut assembly. Kits include chromoly tubing, mount tabs, wing adjusters, and hardware. These kits are sized for comp class cars and do not meet SFI specifications required for some applications. Dragster kits have 44" main supports; altered kits have 24" main supports. There is an additional charge for extra material when taller kits are requested.



PART	DESCRIPTION	PRICE
C42-211	STREAMLINED TUBE WING STRUTS AND STREAMLINED TUBE DIAGONALS (DRAGSTER)	\$454.00
C42-213	STREAMLINED TUBE WING STRUTS AND STREAMLINED TUBE DIAGONALS (ALTERED)	\$384.00



PART	DESCRIPTION	PRICE
C42-210	STREAMLINED TUBE WING STRUTS AND ROUND TUBE DIAGONALS (DRAGSTER)	\$354.00
C42-212	STREAMLINED TUBE WING STRUTS AND ROUND TUBE DIAGONALS (ALTERED)	\$284.00



PART	DESCRIPTION	PRICE
C42-200	ROUND TUBE WING STRUTS AND ROUND TUBE DIAGONALS (DRAGSTER)	\$254.00
C42-202	ROUND TUBE WING STRUTS AND ROUND TUBE DIAGONALS (ALTERED)	\$234.00



FRONT CANARD WINGS

- Proven NACA profiles. (downforce and drag data shown below)
- Available in 6", 8", 12", 14", 18" wide X 10" cord length. (custom widths available)
- 1" diameter aluminum mount tube, aircraft aluminum skin is .032" thick.
- Your choice of these three tip plate profiles.
- Durable all aluminum construction includes our superior quality CNC machined ribs.
- *Select tip plate profile and include letter at the end of part number (Ex. C42-122A)*

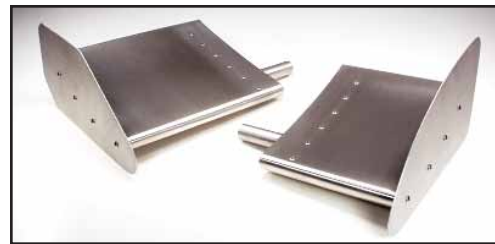

With outer tips

CANARD WINGS WITH OUTER TIPS

Inner edge may be trimmed to match body contour.

PART	DESCRIPTION	PRICE
C42-122	6" WIDE	\$299.00/PR
C42-124	8" WIDE	\$299.00/PR
C42-126	12" WIDE	\$299.00/PR
C42-128	14" WIDE	\$299.00/PR
C42-132	18" WIDE	\$339.00/PR
C42-130	CUSTOM WIDTH/TUBE DIA.	CALL US

WING TIP PROFILES

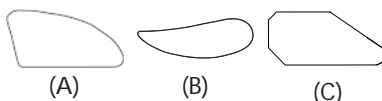

Assembled with billet CNC machined ribs.

CANARD WINGS WITH INNER AND OUTER TIPS

PART	DESCRIPTION	PRICE
C42-123	6" WIDE	\$349.00/PR
C42-125	8" WIDE	\$349.00/PR
C42-127	12" WIDE	\$349.00/PR
C42-129	14" WIDE	\$349.00/PR

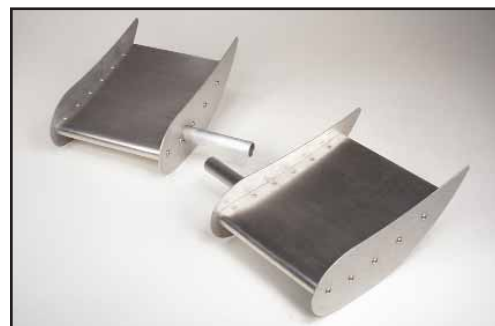

With inner and outer tips



Without inner tip plates for profile fit to body.

FRONT WING DOWNFORCE/DRAG DATA

Calculated values based on ideal environmental conditions & 12" x 10" wing size.

		50 MPH	100 MPH	150 MPH	200 MPH
8° ANGLE OF ATTACK	DOWNFORCE	5.2 lbs	20.8 lbs	46.8 lbs	83.1 lbs
	DRAG	.05 lbs	.2 lbs	.4 lbs	.7 lbs
10° ANGLE OF ATTACK	DOWNFORCE	5.5 lbs	22 lbs	49.4 lbs	87.9 lbs
	DRAG	.05 lbs	.2 lbs	.5 lbs	.8 lbs
12° ANGLE OF ATTACK	DOWNFORCE	6.6 lbs	26.2 lbs	58.9 lbs	104.7 lbs
	DRAG	.1 lbs	.3 lbs	.6 lbs	1.1 lbs

WING ADJUSTER KIT

Includes aluminum adjuster links (7-3/4" long), left hand 5/16" rod ends, and right hand threaded slot clevis with 3/16" slot and 5/16" hole.



PART #	DESCRIPTION	PRICE
C42-182	ADJ. LINK KIT	\$64.95/PR
C42-180	ADJ. LINKS ONLY	\$9.95/EA

BUTTERFLY STEERING WHEEL

The unique finger grips ensure positive control; ergonomic design provides a difference you can feel. Heat treated aluminum is precision CNC machined, micro polished featuring smooth radius corners. Lightest wheel available using aluminum grips.



Measures 6-1/2" deep x 7-1/2" wide.

PART #	DESCRIPTION	PRICE
C42-482	WHEEL W/ POLISHED GRIPS	\$79.95
C42-482-B	BUTTON TAB WHEEL W/POLISHED GRIPS	\$79.95
C42-484	WHEEL W/ RED GRIPS	\$79.95
C42-484-B	BUTTON TAB WHEEL W/ RED GRIPS	\$79.95
C42-486	WHEEL W/ BLUE GRIPS	\$79.95
C42-486-B	BUTTON TAB WHEEL W/ BLUE GRIPS	\$79.95
C42-487	WHEEL W/ BLACK GRIPS	\$79.95
C42-487-B	BUTTON TAB WHEEL W/ BLACK GRIPS	\$79.95
C42-480	WHEEL W/O GRIPS	\$48.95
C42-480-B	BUTTON TAB WHEEL W/O GRIPS	\$48.95



Optional button tab

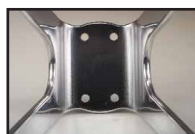

Add "D" to the end of part number for pre-drilled 4-bolt mounting holes. 3/16" dia., .750" x 1.648" bolt pattern. (\$5.00 extra)

REPLACEMENT GRIPS

Four piece aluminum grip set fits Pro-Werks steering wheel only. Includes stainless fasteners.



PART #	DESCRIPTION	PRICE
C42-490	POLISHED GRIPS	\$49.95
C42-491	RED GRIPS	\$49.95
C42-492	BLUE GRIPS	\$49.95
C42-493	BLACK GRIPS	\$49.95

QUICK RELEASE STEERING HUB

Compact and lightweight, features a built-in spring loaded release pin. The cupped non-skid release button provides one finger operation. Precision CNC machined, includes hex adapter, bored with 5/8" ID hole. Meets 42.1 SFI spec.



PART #	DESCRIPTION	PRICE
C52-200	3 BOLT (1/4" HOLES ON 1.750" BOLT CIRCLE)	\$69.95
C52-210	3 BOLT (5/16" HOLES ON 1.750 BOLT CIRCLE)	\$69.95
C52-220	4 BOLT (3/16" HOLES, .750" x 1.648" BOLT PATTERN)	\$69.95
C52-230	UNDRILLED (2-5/8" DIA FLANGE)	\$69.95
C52-254	HEX SHAFT ONLY (5/8" ID)	\$8.95

ADAPTER STUB

Provides 5/8" dia. for hex adapter, when using larger tubing. Universal stepped end accommodates 3/4", 7/8", or 1" dia. tubing with .065" wall thickness.

PART #	DESCRIPTION	PRICE
C52-260	ADPT STUB	\$8.95



ADAPTER FLANGE

Converts any 3 bolt steering flange with 1 3/4" bolt circle using 5/16" dia. bolts. Available for the Grant style 5 bolt or Formula 9 bolt steering wheel.

PART #	DESCRIPTION	PRICE
C52-250	5 BOLT ADAPT FLANGE	\$22.95
C52-251	9 BOLT ADAPT FLANGE	\$22.95



QUICK RELEASE STEERING HUB

Anodized aluminum steering hub with special weld-on inner steel shaft. Spring-loaded quick release pin stays on the hub at all times. Popular 3-bolt pattern with 1 3/4" bolt circle uses 5/16" mount bolts.

PART #	DESCRIPTION	PRICE
270-2017	HUB W/ 5/8" ID HEX SHAFT	\$25.53
270-2016	HUB W/ 3/4" ID HEX SHAFT	\$25.53
300-2020	HEX SHAFT ONLY 5/8" ID	\$7.22
300-2019	HEX SHAFT ONLY 3/4" ID	\$7.22





STILETTO RACK-N-PINION

These lightweight, high quality steering boxes are precision machined from high strength steel and 7075-T6 billet aluminum. Fitted with self-lubricating bronze bearings, pinion seal, and nylon reinforced neoprene boots. All rack-n-pinions include 5/8"-36 splined coupler except the C42-348, which includes a 9/16"-26 splined coupler.

PART #	DESCRIPTION	RATIO	TOTAL PINION ROTATION	TOTAL RACK TRAVEL	LENGTH	PRICE
C42-336	RACK-N-PINION (JR. DRAGSTER) VERTICAL WITH 5/16" ROD ENDS	12:1	1-1/8 TURNS	3"	8-1/2"	\$214.00
C42-339	RACK-N-PINION VERTICAL WITH 3/8" ROD ENDS	12:1	1-3/4 TURNS	4-1/2"	11-1/4"	\$224.35
C42-340	RACK-N-PINION HORIZONTAL WITH 3/8" ROD ENDS	12:1	1-3/4 TURNS	4-1/2"	11-1/4"	\$224.35
C42-341	RACK-N-PINION (LGT.WEIGHT, ALL ALUM.) VERTICAL WITH 3/8" ROD ENDS	12:1	1-3/4 TURNS	4-1/2"	11-1/4"	\$224.35
C42-344	RACK-N-PINION VERTICAL WITH 3/8" ROD ENDS	15:1	2-1/4 TURNS	4-3/4"	11-1/4"	\$245.00
C42-348	RACK-N-PINION VERTICAL WITH 3/8" ROD ENDS	20:1	2-3/4 TURNS	4-3/4"	11-1/4"	\$245.00
C42-352	REPL. BOOTS (2) W/WIRES (4)	N/A	N/A	N/A	N/A	\$36.40
C42-353	SPLINED COUPLER 5/8"-36	N/A	N/A	N/A	N/A	\$7.98



CHOOSING VERTICAL OR HORIZONTAL BOLT CENTERLINE



Horizontal is for suspended or rigid applications.



Vertical is only for rigid applications.

Horizontal

Vertical

Choosing the right steering ratio for your application:

- 12:1 Fast Ratio- Dragsters & Sand Buggies
- 15:1 Medium Ratio- Roadsters & Alteredds
- 20:1 Slow Ratio- Bonneville & High Speed

PINTO RACK-N-PINION

Popular for door car construction. This new chrome unit is a direct replacement for a pinto rack. Has 3-7/8 turns at the pinion with 9/16"-26 spline. Coupler not included.



PART #	DESCRIPTION	PRICE
C42-400	PINTO RACK-N-PINION	\$259.00
C42-403	COUPLER 9/16"-26 SPLINE x 3/4" BORED	\$10.95

PINTO RACK BRACKET

Billet CNC machined aluminum bracket provides sanitary mounting of OEM style Pinto Rack-N-Pinion.



PART #	DESCRIPTION	PRICE
C42-404	BRACKET ONLY	\$54.95
C42-405	BRACKET W/ WELD ON MOUNTS	\$64.95

PINTO TIE ROD KIT

Weld on tie rod kit for Pinto Rack-N-Pinion.

PART #	DESCRIPTION	PRICE
C42-425	TIE ROD KIT	\$44.50



TIE ROD TUBE KIT

Everything necessary for construction of chromoly tie rods when using a Stiletto Rack-N-Pinion.



PART #	DESCRIPTION	PRICE
C42-420	(2) 3/4" DIA. X 18" TUBE W/ 3/8" ROD ENDS & FASTENERS	\$39.95
C42-421	(2) 7/8" DIA. X 20" TUBE W/ 7/16" ROD ENDS & FASTENERS	\$44.50

Add \$30.00 for factory tig welding (c-c dimensions required)

STEERING BEARING

Self-aligning sealed bearing for smooth operation. Also available with polished billet aluminum cover for super clean appearance.



PART #	DESCRIPTION	PRICE
C73-080	FITS 3/4" DIA SHAFT	\$17.95
C73-080-B	FITS 3/4" DIA SHAFT W/ BILLET COVER	\$41.95
C73-081	FITS 7/8" DIA SHAFT	\$17.95
C73-081-B	FITS 7/8" DIA SHAFT W/ BILLET COVER	\$41.95
C73-082	FITS 1" DIA SHAFT	\$17.95
C73-082-B	FITS 1" DIA SHAFT W/ BILLET COVER	\$41.95
C73-085	BILLET COVER ONLY	\$24.95
C73-162	WELD ON STEERING BRACKET	\$3.86

SPE FUNNY CAR BOX

Ideal for front engine applications such as altered, roadsters, and funny cars. Billet aluminum housing provides superior strength and durability. 5/8"-36 splined coupler and pitman arm included. 1-1/2 turns total pinion rotation.

PART #	DESCRIPTION	LENGTH	PRICE
C42-380	STEERING BOX-STD	12-1/4"	\$340.73
C42-381	STEERING BOX-LONG	14-3/8"	\$340.73
C42-382	STEERING BOX-SHORT	2-5/8"	\$340.73
C42-383	SPLINED COUPLER, 5/8"-36	N/A	\$7.98
C42-385	PITMAN ARM,5"	N/A	\$28.05

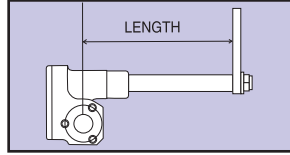

BLOCK AND PIN U-JOINT

High-alloy quality block and pin U-Joints are strong enough for moderate load applications.



PART #	DESCRIPTION	PRICE
C42-360	3/4" O.D. SOLID x 3/4" O.D. SOLID	\$51.00
C42-362	3/4" I.D. BORED x 3/4" I.D. BORED	\$41.25

HEAVY DUTY ROLLER BEARING U-JOINT

Durable and dependable smooth operation, ideal for hi-load applications.



PART #	DESCRIPTION	APPLICATION	PRICE
C42-365	5/8" ID BORED x 5/8" ID BORED	UNIVERSAL	\$54.95
C42-366	3/4" ID BORED x 3/4" ID BORED	UNIVERSAL	\$54.95
C42-368	9/16"-26 SPLINE X 3/4" ID BORED	PINTO RACK	\$54.95
C42-370	5/8"-36 SPLINE x 3/4" ID BORED	STILETTO RACK/ SPE FUNNY CAR	\$54.95
C42-372	3/4"-36 SPLINE x 3/4" ID BORED	CHEVY MAN/ PINTO POWER	\$54.95
C42-374	3/4"-30 SPLINE x 3/4" ID BORED	NEW CHEVY POWER	\$54.95
C42-376	13/16"-36 SPLINE X 3/4" ID BORED	CHEVY POWER	\$54.95
C42-378	1"-48 SPLINE x 3/4" ID BORED	GM STOCK	\$69.95

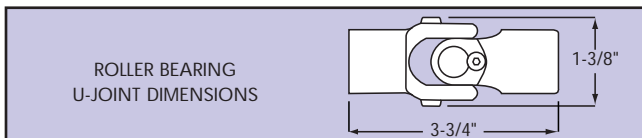

SELF-LUBRICATING BEARINGS

Both materials are ideally suited for low speed and medium load applications. Selection should be determined by size requirement. Sold in 2 packs.

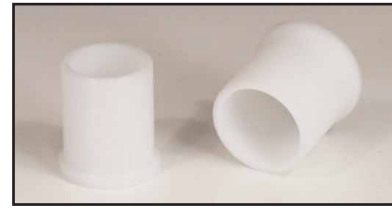

PART #	DESCRIPTION	PRICE
C42-095-2	5/8" ID FITS IN 7/8" x .049 TUBE	\$14.95
C42-096-2	3/4" ID FITS IN 1" x .049 TUBE	\$14.95



PART #	DESCRIPTION	PRICE
C52-090-2	5/8" ID FITS IN 7/8" x .058 TUBE	\$11.95
C52-092-2	3/4" ID FITS IN 1-1/8" x .058 TUBE	\$13.00
C52-094-2	7/8" ID FITS IN 1-1/4" x .058 TUBE	\$13.90
C52-096-2	1" ID FITS IN 1-3/8" x .058 TUBE	\$15.00
C52-098-2	1-1/4" ID FITS IN 1-5/8" x .058 TUBE	\$19.90

ANTI PUSH BACK

Available for 5/8" dia. or 3/4" dia. shaft. Pilot drilled for two piece shaft construction. Safety feature required by NHRA.



PART #	DESCRIPTION	PRICE
C42-350	5/8" DIAMETER	\$22.50
C42-351	3/4" DIAMETER	\$22.50

13" STEERING WHEEL

All aluminum! The lightest steering wheel available - only 2#. Durable foam grip is comfortable and extends onto spokes.



PART #	DESCRIPTION	PRICE
C42-495	13" STEERING WHEEL	\$75.95

STILETTO CHROMOLY SPINDLES

High strength, heat treated spindles are machined from chromoly billet.

Bushings and thrust washers support the 8620 centerless ground king pins. Spindles are dimensionally the same as the English Ford Anglia. Each pair includes (2) spindles, (2) bosses, (2) 5" arms, (2) king pins, and hardware.

Stiletto PRODUCTS



PART #	DESCRIPTION	PRICE
C42-454	STANDARD SPINDLE SET*	\$277.20
C42-456	SPINDLE BOSS (.687" I.D. x 2")	\$8.15
C42-457	STEERING ARM 5" x 3/16"	\$12.04
C42-458	STEERING ARM 6" x 1/4"	\$12.04
C42-460	THRUST WASHER (.095" THICK)	\$2.31
C42-465	KING PIN BUSHING - NEW STYLE (.687" I.D. x .782" O.D.-STEEL BACKED)	\$3.95
C42-461	KING PIN BUSHING - OLD STYLE, WITH SHOULDER, (.687" I.D. x .816" O.D.-BRONZE TYPE)	\$3.95
C42-462	SPINDLE NUT (5/18"-18)	\$1.05
C42-463	KING PIN (.687" O.D. X 3-1/4")	\$7.32
C42-464	KING PIN LONG (.687" O.D. X 4-1/4")	\$9.95

*Spindle bosses are included.

Note: All spindles listed on this page are .984" inside diameter and .625" outside diameter. Steering arm length is measured from center of king pin to center of bolt hole. King pin angle is 8 degrees.

TOW CAPS

Billet aluminum spindle caps allow easy hook up of tow strap. Sold in pair.



PART #	DESCRIPTION	PRICE
C42-477	FITS STILETTO SPINDLE (1/4" HOLES .890" x .890" BOLT PATTERN)	\$22.95
C42-478	FITS SPE SPINDLE (1/4" HOLES 1" x 1" BOLT PATTERN)	\$22.95
C42-488	FITS MW SPINDLE (5/16" HOLES 1.032" x 1.032" BOLT PATTERN)	\$22.95
C42-489	FITS P&S SPINDLE (1/4" HOLES .875" x .875" BOLT PATTERN)	\$22.95

SPE ALUMINUM SPINDLES

These lightweight 7075-T6 billet aluminum spindles are designed for the weight conscious builder. Not recommended for front engine cars. Approximately 1 lb. lighter per spindle than a chromoly spindle. Spindles are dimensionally the same as the English Ford Anglia. Each pair includes (2) spindles, (2) 5" arms, (2) king pins, and hardware.



PART #	DESCRIPTION	PRICE
C42-466	ALUMINUM SPINDLE SET*	\$321.75
C42-469	SPINDLE BOSS (.687" I.D. x 1.875")	\$11.39
C42-471	STEERING ARM 5" x 1/4"	\$20.63
C42-473	STEERING ARM 6" x 1/4"	\$20.63
C42-474	KING PIN (.687" O.D. x 3")	\$16.09
C42-475	KING PIN BUSHING, WITH SHOULDER (.687" ID x .816" O.D.)	\$6.60
C42-476	SPINDLE NUT (5/8"-18)	\$1.65

*Spindle bosses not included.

WELD-ON FRONT SPINDLE

Ideal for custom suspension fabrication. CNC machined from 4130 chromoly. Dimensionally the same as English Ford Anglia.



PART #	DESCRIPTION	PRICE
C42-585-2	WELD-ON SPINDLE	\$99.90/PR

BILLET WHEEL HUB

CNC machined from billet aluminum and anodized. Accepts bolt-on wheels for dragster and funny car style spindles that are dimensionally the same as English Ford Anglia. Features multiple bolt patterns 4-1/2", 4-3/4", or 5" with 1/2"-20 thread.



PART #	DESCRIPTION	PRICE
C42-590	BILLET WHEEL HUB	\$115.95/EA
C42-592	BEARINGS & SEAL FOR ONE HUB	\$38.95
C42-624	DUST CAP	\$6.95/EA

STEERING SHAFT KITS

Two new styles to choose from, includes all the necessary components to fabricate a complete steering shaft assembly.



PART #	DESCRIPTION	PRICE
C42-040	3/4" DIAMETER KIT	\$100.95

Kit Includes:

- 1-pc 3/4" x .065" tube 42" long
- 1 - 3 bolt Quick Release Steering Hub
- 1 - 5/8"-36 Splined U-Joint
- 1 - 3/4" Nylon Bushing
- 1 - Bushing Sleeve



PART #	DESCRIPTION	PRICE
C42-036	5/8" DIAMETER KIT	\$149.95

Kit Includes:

- 1-pc 5/8" x .065" tube 48" long
- 1-pc 5/8" x .065" tube 72" long
- 1 - 5/8"-36 Splined Coupler, 1 - Anti-Push Back
- 2 - 5/8" Nylon Bushings, 2 - Bushing Sleeves
- 1 - 4 bolt Quick Release Steering Hub (SFI)

ULTRA LIGHT WHEEL (17" dia. x 1.875" wide)

Our wheels tip the scale at a mere 4 lbs. each. These one piece hydro-formed aircraft aluminum halves are jig welded, finish machined, hand sanded, and micro polished. Accepts most popular front 17" tires, such as Good Year Front Runner, or lightweight sand tires. These wheels are ideal for lightweight cars, running 4 and 6-cyl. engines.



Maximum vehicle weight is 800#.

PART #	DESCRIPTION	PRICE
C42-600	ULTRA LIGHT WHEEL	\$157.50/EA
C42-615	LIGHTWEIGHT SAND TIRE*	\$17.90/EA
C42-620	TIRE TUBE	\$6.40/EA
C42-624	DUST CAP	\$6.95
	BEARING SET (4)	
C42-625	2.047" O.D., .984" I.D. (INNER), .625" I.D. (OUTER)	\$32.50

*For lightweight sand application ONLY.

FRONT AXLE

Precision machined chromoly axle is tig welded on location in our accurate fixture. Width dimension is from center of tire to center of tire. Drop dimension is from bottom of axle to center line of spindle. Stiletto bosses measure 2" tall, SPE bosses are 1.875" tall.



PART #	DESCRIPTION	MATERIAL	PRICE
C42-447	DRAGSTER FRONT AXLE 39" CENTERS, 6" DROP W/ 6" FLAT, STILETTO BOSSES	1-1/2" x .120" 4130	\$135.00
C42-437	DRAGSTER FRONT AXLE 39" CENTERS, 6" DROP W/ 6" FLAT, SPE BOSSES	1-1/2" x .120" 4130	\$135.00
C42-448	DRAGSTER FRONT AXLE 36" CENTERS, 6" DROP W/ 6" FLAT, STILETTO BOSSES	1-1/2" x .120" 4130	\$135.00
C42-438	DRAGSTER FRONT AXLE 36" CENTERS, 6" DROP W/ 6" FLAT, SPE BOSSES	1-1/2" x .120" 4130	\$135.00
C42-449	ALTERED FRONT AXLE 40" CENTERS STRAIGHT STILETTO BOSSES	1-5/8" x .120" 4130	\$130.00
C42-439	ALTERED FRONT AXLE 40" CENTERS STRAIGHT SPE BOSSES	1-5/8" x .120" 4130	\$130.00

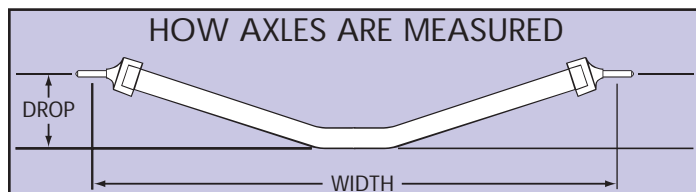

THREE BAR FRONT END KIT

The new style three bar front end is now available in a complete economical kit, including chromoly tubing, mounting tabs, inner bosses, grade 8 hardware, and spindle bosses.



Kit includes both sides, half of kit is shown.

PART #	DESCRIPTION	PRICE
C42-443	DRAGSTER KIT - 3/4" TUBE DIA. W/STILETTO BOSSES (2" TALL)	\$119.95
C42-444	FRONT ENGINE KIT - 7/8" TUBE DIA. W/STILETTO BOSSES (2" TALL)	\$124.95
C42-445	DRAGSTER KIT - 3/4" TUBE DIA. W/ SPE BOSSES (1.875" TALL)	\$119.95
C42-446	FRONT ENGINE KIT - 7/8" TUBE DIA. W/SPE BOSSES (1.875" TALL)	\$124.95
C42-441	BOSS, 1" LONG 5/8" O.D. 5/16" I.D.	\$5.95
C42-442	BOSS, 1-1/4" LONG 5/8" O.D. 5/16" I.D.	\$5.95

DRAGSTER PEDAL ASSEMBLY

Super lightweight plated chromoly pedals glide on a nylon bushed aircraft aluminum cross shaft. Multiple snap ring grooves enable side to side positioning of pedals on shaft, total adjustment is 1-1/4" per pedal in 1/4" increments. Standard features include non-skid surface on brake pedal and gas pedal with toe hook, includes chromoly mounting tabs and hardware.



PART #	DESCRIPTION	PRICE
C42-080	PEDAL KIT W/ 14" SHAFT	\$149.95
C42-081	PEDAL KIT W/ 15" SHAFT	\$149.95
C42-082	PEDAL KIT W/ 16" SHAFT	\$149.95
C42-083	PEDAL KIT W/ 17" SHAFT	\$149.95
C42-084	PEDAL KIT W/18" SHAFT	\$149.95
C42-085	PEDAL KIT W/ 19" SHAFT	\$149.95
C42-086	PEDAL KIT W/ 20" SHAFT	\$149.95
C42-091	DRAGSTER GAS PEDAL*	\$62.90
C42-092	DRAGSTER BRAKE PEDAL*	\$50.90

*Nylon Bushings Installed

PEDAL SHAFT



PART #	DESCRIPTION	PRICE
C42-070	14" PEDAL SHAFT	\$29.95
C42-071	15" PEDAL SHAFT	\$29.95
C42-072	16" PEDAL SHAFT	\$29.95
C42-073	17" PEDAL SHAFT	\$29.95
C42-074	18" PEDAL SHAFT	\$29.95
C42-075	19" PEDAL SHAFT	\$29.95
C42-076	20" PEDAL SHAFT	\$29.95

MULTI MOUNT BRACKETS

Optional weld mount brackets allow total of 6" of pedal assembly adjustment in 3/4" increments. Laser cut 1/8" thick chromoly with 5/16" dia. holes.



PART #	DESCRIPTION	PRICE
C73-273	MULTI MOUNT BRACKETS	\$24.95/PR

ADJUSTABLE PEDAL STOP

This universal weld-on, adjustable pedal stop can be used with levers or pedals to prevent over-traveling.



PART #	DESCRIPTION	PRICE
C42-110	ADJUSTABLE PEDAL STOP	\$14.99

CONTROL LEVER

Lightweight, heat treated aluminum control levers are designed for custom installations. Perfect for Dragsters, Altereds and Funny cars. CNC Machined 1/4" thick aluminum with 3/8" dia. pivot hole and micro polished finish. Smooth radiused edges. Aluminum grips provide comfort and control.



PART #	DESCRIPTION	PRICE
C42-512	18" LONG LEVER W/ POLISHED GRIPS	\$72.95
C42-514	18" LONG LEVER W/ RED GRIPS	\$72.95
C42-516	18" LONG LEVER W/ BLUE GRIPS	\$72.95
C42-517	18" LONG LEVER W/ BLACK GRIPS	\$72.95
C42-519	18" LONG LEVER W/O GRIPS	\$39.95
C42-522	20" LONG LEVER W/ POLISHED GRIPS	\$72.95
C42-524	20" LONG LEVER W/ RED GRIPS	\$72.95
C42-526	20" LONG LEVER W/ BLUE GRIPS	\$72.95
C42-527	20" LONG LEVER W/ BLACK GRIPS	\$72.95
C42-529	20" LONG LEVER W/O GRIPS	\$39.95

SHUT OFF LEVER

Designed to fit Pro-werks control levers. Ideal for chute release or fuel shut off. CNC machined from billet aluminum.



PART #	DESCRIPTION	PRICE
C42-507	SHUT OFF LEVER	\$39.95

CHUTE/SHUT OFF LEVER

Universal aluminum lever measures 5" long by 3/16" thick with 3/16" dia. holes.



PART #	DESCRIPTION	PRICE
C42-510	CHUTE/SHUT OFF LEVER	\$9.95

FRONT AND REAR MOTOR PLATES

All of our Motor Plates are 6061-T6 aluminum, CNC precision machined "In House" to exact tolerances for optimum fit and finish.

MID MOTOR PLATE

Made from 6061-T6 aluminum. May be trimmed to fit your application. Includes dowel pin locations and starter hole.

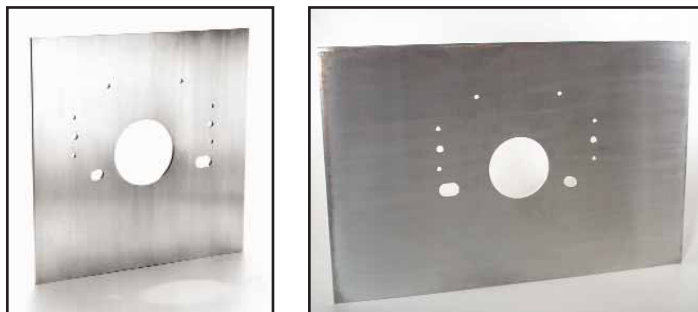

PART #	DESCRIPTION	SIZE	PRICE
C52-302	BLANK	24" x 24" x 1/4"	\$79.95
C52-303	BLANK	24" x 24" x 3/8"	\$119.95
C52-311	CENTER HOLE ONLY	24" x 24" x 1/4"	\$95.95
C52-312	CENTER HOLE ONLY	24" x 24" x 3/8"	\$135.95
C52-321	SB & BB CHEVY BOLT PATTERN	24" x 24" x 1/4"	\$114.95
C52-421	SB & BB CHEVY BOLT PATTERN	24" x 36" x 1/4"	\$159.95
C52-322	SB & BB CHEVY BOLT PATTERN	24" x 24" x 3/8"	\$154.95
C52-324	UNIVERSAL	24" x 24" x 1/4"	\$110.95
C52-424	UNIVERSAL	24" x 36" x 1/4"	\$155.95
C52-326	UNIVERSAL	24" x 24" x 3/8"	\$150.95
C52-336	SB MOPAR BOLT PATTERN	24" x 24" x 1/4"	\$124.95
C52-436	SB MOPAR BOLT PATTERN	24" x 36" x 1/4"	\$169.95
C52-337	SB MOPAR BOLT PATTERN	24" x 24" x 3/8"	\$164.95
C52-346	BB MOPAR BOLT PATTERN	24" x 24" x 1/4"	\$124.95
C52-446	BB MOPAR BOLT PATTERN	24" x 36" x 1/4"	\$169.95
C52-347	BB MOPAR BOLT PATTERN	24" x 24" x 3/8"	\$164.95
C52-356	SB FORD BOLT PATTERN	24" x 24" x 1/4"	\$124.95
C52-456	SB FORD BOLT PATTERN	24" x 36" x 1/4"	\$169.95
C52-357	SB FORD BOLT PATTERN	24" x 24" x 3/8"	\$164.95
C52-366	BB FORD BOLT PATTERN	24" x 24" x 1/4"	\$124.95
C52-466	BB FORD BOLT PATTERN	24" x 36" x 1/4"	\$169.95
C52-367	BB FORD BOLT PATTERN	24" x 24" x 3/8"	\$164.95

PROFIED FRONT MOTOR PLATE

Complete and ready to install. Includes holes for chassis tabs. Notched 1 3/8" dia. to accept floating saddle or direct mounts. 19 1/2" centers on frame rail notches.



PART #	DESCRIPTION	PRICE
C52-550	1/4" THICK SB CHEVY	\$84.95
C52-551	3/8" THICK SB CHEVY	\$114.95
C52-555	1/4" THICK BB CHEVY	\$84.95
C52-556	3/8" THICK BB CHEVY	\$114.95



PROFIED MID MOTOR PLATE

Ready to install. Designed to work with our front profiled motor plates. Available for either 1 1/4" or 1 1/2" dia. frame rails. 19 1/2" centers on frame rail notches.

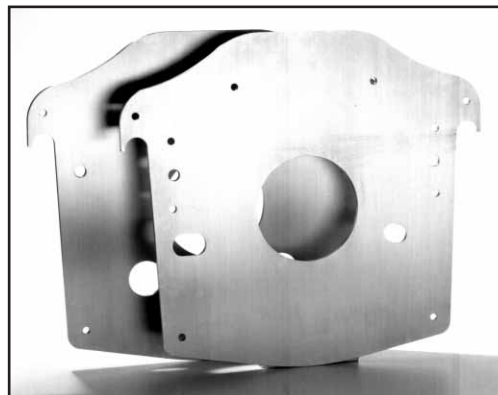

PART #	DESCRIPTION	NOTCH	PRICE
C52-400	1/4" THICK UNIVERSAL	1-1/4"	\$150.95
C52-401	3/8" THICK UNIVERSAL	1-1/4"	\$174.95
C52-405	1/4" THICK UNIVERSAL	1-1/2"	\$150.95
C52-406	3/8" THICK UNIVERSAL	1-1/2"	\$174.95
C52-410	1/4" THICK SB/BB CHEVY	1-1/4"	\$154.95
C52-411	3/8" THICK SB/BB CHEVY	1-1/4"	\$179.95
C52-415	1/4" THICK SB/BB CHEVY	1-1/2"	\$154.95
C52-416	3/8" THICK SB/BB CHEVY	1-1/2"	\$179.95

FRONT MOTOR PLATE

Provides increased chassis strength. Allows easy engine installation & removal. 1/4" thick & 36" long. Machined with water passages.

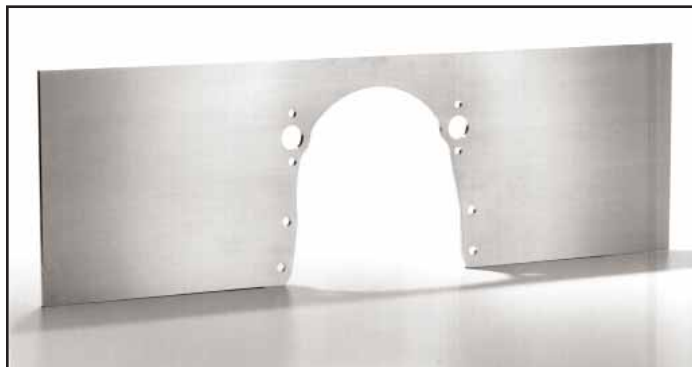

PART #	DESCRIPTION	PRICE
C52-500	SMALL BLOCK CHEVY	\$94.95
C52-501	BIG BLOCK CHEVY	\$94.95
C52-505	SMALL BLOCK MOPAR	\$99.95
C52-506	BIG BLOCK MOPAR	\$99.95
C52-510	SMALL BLOCK FORD	\$99.95
C52-515	BIG BLOCK FORD	\$99.95
C52-520	CLEVELAND FORD	\$99.95

FLOATING SADDLE MOUNT

All chromoly construction, tig welded, several sizes available. Clamps sold separately, listed below.



PART #	SIZE	USES CLAMP	PRICE
C73-321	FITS 1" DIA.	C73-303	\$21.95
C73-322	FITS 1-1/8" DIA.	C73-304	\$21.95
C73-323	FITS 1-1/4" DIA.	C73-304	\$21.95
C73-324	FITS 1-3/8" DIA.	C73-306	\$21.95
C73-325	FITS 1-1/2" DIA.	C73-307	\$21.95
C73-326	FITS 1-5/8" DIA.	C73-307	\$21.95



Shown installed with clamps

STAINLESS CLAMP

Positive clamping band clamp is ideal for floating mounts, add-on brackets, or hose sealing. Fine thread T-bolt includes self-locking nut.



PART #	SIZE	CLAMP RANGE	PRICE
C73-303	1.125" DIA.	1" TO 1-3/16"	\$7.50
C73-304	1.312" DIA.	1-1/4" TO 1-7/16"	\$7.50
C73-306	1.5" DIA.	1-7/16" TO 1-5/8"	\$7.50
C73-307	1.625" DIA.	1-1/2" TO 1-7/8"	\$7.50

REAR END COUPLER

Super tough couplers for powerglide or turbo 350 to 9" rear end.



Female (Fits 9" Pinion)			
PART #	SIZE	PRICE	
U-3627	28 SPLINE PINION	\$76.50	
U-3629	35 SPLINE PINION	\$76.50	



Male (Fits 27 Spline Trans)			
PART #	SIZE	PRICE	
U-3647	3-7/8" LONG	\$81.40	
U-3648	6-3/4" LONG	\$88.28	



Quick Release Male- 2 pc Design (Fits 27 Spline Trans)			
PART #	SIZE	PRICE	
U-3650	4" (SHORT STYLE)	\$126.50	
U-3651	6" (LONG STYLE)	\$137.50	

Two-Piece design slides out to allow trans to be removed without pulling engine or rear end.

HOUSING ENDS

Permit the use of larger outer bearings when narrowing your own rear end housing. Bolt patterns listed on page 30.



PART #	SIZE	PRICE
C42-700	OLDS/PONTIAC (3.150" BORE)	\$58.00/PR
C42-701	BIG FORD (3.150" BORE)	\$58.00/PR
C42-702	SMALL FORD (2.835" BORE)	\$58.00/PR
C42-703	MOPAR/DANA (2.875" BORE)	\$58.00/PR

LATERAL LIMITER KIT

Control engine/trans movement during hard acceleration or braking. Recommended when using motor plates.



PART #	SIZE	PRICE
C42-427	UNIVERSAL KIT	\$59.95
C42-429	9" TO "SHORTY" GLIDE KIT	\$129.95
C42-430	"SHORTY" GLIDE BRACKET ONLY	\$48.95
C42-431	9" BRACKET ONLY	\$48.95



TORSION BAR KIT

CNC machined billet aluminum arms adjuster links include chromoly rod ends. Includes torsion tube, mount tube, tabs, bushings, and hardware. Eliminates body roll for equal traction of both rear tires. Torsion bar is 30" long, may be shortened.

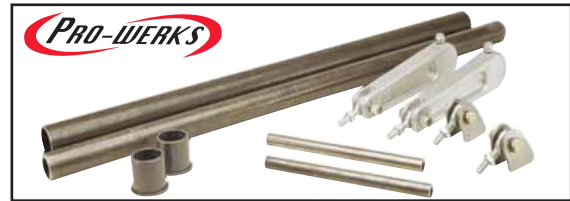

PART #	DESCRIPTION	PRICE
C52-100	TORSION BAR KIT	\$229.95
C52-105	ARM ONLY	\$59.95/EA

WHEEL SPACERS

Hard-anodized billet aluminum wheel spacers are CNC machined for accuracy. Available in either 1/4" or 1/2" thick. Sold in pairs.



PART #	THICKNESS	SIZE	PRICE
C44-001*	1/4"	5 ON 4-1/2", 4-3/4" & 5" BOLT PATTERNS .702" DIA. HOLES	\$54.95
C44-003*	1/2"	5 ON 4-1/2", 4-3/4" & 5" BOLT PATTERNS .702" DIA. HOLES	\$74.95
C44-005*	1/4"	5 ON 5-1/2" BOLT PATTERN "FLOATER TYPE" .702" DIA. HOLES	\$59.95
C44-007*	1/2"	5 ON 5-1/2" BOLT PATTERN "FLOATER TYPE" .702" DIA. HOLES	\$79.95
C44-013*	1/4"	5 ON 135mm & 5 ON 5-1/2" BOLT PATTERN .702" DIA. HOLES	\$59.95
C44-015*	1/2"	5 ON 135mm & 5 ON 5-1/2" BOLT PATTERN .702" DIA. HOLES	\$79.95
C44-017	1/4"	6 ON 5-1/2" BOLT PATTERN .531" DIA. HOLES	\$59.95
C44-019	1/2"	6 ON 5-1/2" BOLT PATTERN .531" DIA. HOLES	\$79.95
C44-021	1/4"	8 ON 170mm & 8 ON 6-1/2" BOLT PATTERN .578" DIA. HOLES	\$69.95
C44-023	1/2"	8 ON 170mm & 8 ON 6-1/2" BOLT PATTERN .578" DIA. HOLES	\$89.95

* Requires stud bushings if using 1/2" dia. Studs

STUD BUSHINGS

These steel bushings reduce wheel spacers with .702" dia. holes. For applications using 1/2" dia. studs.



PART #	SIZE	PRICE
C44-010	1/4" STUD BUSHINGS 1/2" ID (10PK)	\$12.50
C44-011	1/2" STUD BUSHINGS 1/2" ID (10PK)	\$12.50



pro-werks

The Pro-werks line of racing components represents the highest level of design and engineering technology. Manufactured from high quality raw materials and machined on state-of-the-art CNC equipment, Pro-werks products stand for the best in

racing innovation and performance. All bending, welding, machining, and processing is done by skilled professionals who know and understand race car fabrication.

BOTTLE MOUNT

Perfect for nitrous, CO₂, fire, & fresh air bottles. New design may be mounted on tabs or flat surface. Accepts Bar Mount for clamping on round tubing. Micro polished 6061-T6 billet aluminum. CNC machined accuracy. Lightweight, attractive design. Smooth radiused outside corners. Has two 1/4"-20 threaded mount holes 2-5/8" spacing.

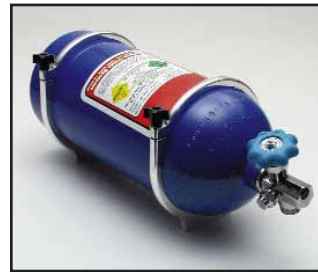

- Sold individually
- Recommend two mounts per bottle
- Listed diameter is the actual bottle diameter, clamp range is minimal (less than 1/16")
- Required by most sanctioning bodies.
- Easy spin knob provides positive, secure clamping and quick bottle loading.

PART #	SIZE	PRICE
C72-101	2" DIA.	\$32.95
C72-102	2-7/8" DIA.	\$32.95
C72-103	3.2" DIA.	\$32.95
C72-104	3.55" DIA.	\$32.95
C72-106	4" DIA.	\$34.95
C72-110	4-1/4" DIA.	\$34.95
C72-107	4-5/16" DIA.	\$34.95
C72-108	4-3/8" DIA.	\$34.95
C72-109	4-1/2" DIA.	\$34.95
C72-111	5" DIA.	\$36.95
C72-112	5.1" DIA.	\$36.95
C72-113	5-1/4" DIA.	\$36.95
C72-115	6.2" DIA.	\$49.95
C72-117	6.9" DIA.	\$49.95

BAR MOUNT

Clamps around tubing. Eliminates the need for welding on chassis. Accepts Bottle Mounts listed above, when attachment to round tubing is necessary. Ideal for add-on accessories such as fuel pumps, electronic devices, etc. 1/4" bolt spacing is 2-5/8".



PART #	SIZE	PRICE
C72-300	3/4" DIA.	\$24.95
C72-301	7/8" DIA.	\$24.95
C72-302	1" DIA.	\$24.95
C72-303	1-1/8" DIA.	\$24.95
C72-304	1-1/4" DIA.	\$24.95
C72-305	1-3/8" DIA.	\$24.95
C72-306	1-1/2" DIA.	\$24.95
C72-307	1-5/8" DIA.	\$24.95
C72-308	1-3/4" DIA.	\$24.95
C72-309	1-7/8" DIA.	\$24.95
C72-310	2" DIA.	\$24.95

LIGHTWEIGHT 2" BOTTLE MOUNT

Fits 2" dia. 10oz. CO₂ bottle. Flat mount only, will not accept bar mount. Has two 1/4"-20 threaded mount holes 1-1/2" spacing. Recommend two mounts per bottle. *If bar mountable version is required order part #C72-101 listed above.*

PART #	DESCRIPTION	PRICE
C72-100	2" DIA.	\$22.95



RESERVOIR CLAMP

Provides secure mounting of remote reservoirs of shock absorbers without cylinder distortion. May also be used for fuel pumps, filters, etc. Micro polished aluminum may be flat mounted or accepts bar mount for clamping on round tubing. Has two 1/4"-20 threaded mount holes 2-5/8" spacing.



PART #	DESCRIPTION	PRICE
C72-320	1.910" DIA.	\$32.95
C72-321	1.935" DIA.	\$32.95
C72-322	2.010" DIA.	\$32.95
C72-324	2.437" DIA.	\$32.95
C72-325	2.475" DIA.	\$32.95
C72-326	2.5" DIA.	\$32.95



CO₂ BOTTLE

Don't get caught at the track without a spare. Sold empty.

PART #	DESCRIPTION	PRICE
C72-080	10 OZ. CO ₂ BOTTLE (16-3/4" x 2)	\$64.95
C72-084	2-1/2# CO ₂ BOTTLE (14" x 4-3/8")	\$84.95



CO₂ BOTTLE ACCESSORIES

PART #	DESCRIPTION	PRICE
C72-086	"THERMO" BRAND REPLACEMENT PRESSURE RELIEF (3000#)	\$4.50
C72-087	"SHERWOOD" BRAND REPLACEMENT PRESSURE RELIEF (3000#)	\$4.50
C72-088	O RING SEAL	\$4.95



CO₂ REGULATOR

These brass CO2 regulators are preset at the pressure listed (non-adjustable). Includes bottle pressure gauge with one 1/4" NPT outlet.



PART #	DESCRIPTION	PRICE
C72-089	90# REGULATOR W/ GAUGE	\$62.95
C72-090	150# REGULATOR W/ GAUGE	\$62.95
C72-091	220# REGULATOR W/ GAUGE	\$64.75
C72-092	CUSTOM REGULATOR W/ GAUGE (ALLOW 3-4 WEEKS FOR DELIVERY)	\$74.95
C72-095	REPLACEMENT GAUGE 1/8" NPT 1-2000	\$17.70



FEMALE WELD BUNG

Weld in bungs simplify tank fabrication. Available in choice of steel or aluminum, AN female for positive "O" ring seal or NPT (Pipe) thread.



PART #	DESCRIPTION	PRICE
C73-669	NPT PIPE BUNG 1/16" ALUM	\$5.50
C73-670	NPT PIPE BUNG 1/8" ALUM	\$3.03
C73-671	NPT PIPE BUNG 1/4" ALUM	\$3.18
C73-672	NPT PIPE BUNG 3/8" ALUM	\$5.68
C73-673	NPT PIPE BUNG 1/2" ALUM	\$6.53
C73-674	NPT PIPE BUNG 3/4" ALUM	\$9.39
C73-679	NPT PIPE BUNG 1/16" STEEL	\$5.50
C73-680	NPT PIPE BUNG 1/8" STEEL	\$5.95
C73-681	NPT PIPE BUNG 1/4" STEEL	\$5.95
C73-682	NPT PIPE BUNG 3/8" STEEL	\$6.95
C73-683	NPT PIPE BUNG 1/2" STEEL	\$7.95



PART #	DESCRIPTION	PRICE
C73-650	AN BUNG #4 ALUM 7/16"-20	\$6.53
C73-651	AN BUNG #6 ALUM 9/16"-18	\$6.53
C73-652	AN BUNG #8 ALUM 3/4"-16	\$6.53
C73-653	AN BUNG #10 ALUM 7/8"-14	\$10.25
C73-654	AN BUNG #12 ALUM 1-1/16"-12	\$13.95
C73-655	AN BUNG #16 ALUM 1-5/16"-12	\$16.77
C73-660	AN BUNG #4 STEEL 7/16"-20	\$4.95
C73-661	AN BUNG #6 STEEL 9/16"-18	\$5.50
C73-662	AN BUNG #8 STEEL 3/4"-16	\$6.95
C73-663	AN BUNG #10 STEEL 7/8"-14	\$8.25
C73-664	AN BUNG #12 STEEL 1-1/16"-12	\$11.75
C73-665	AN BUNG #16 STEEL 1-5/16"-12	\$14.25

HIGH FLOW MALE WELD BUNG

Contoured inlet for maximum flow. Precision CNC machined from 6061-T6 aluminum. Stepped shoulder provides location in hole on a flat surface, in a tank, or end of tubing while welding.

PART #	DESCRIPTION	FLANGE O.D.	PRICE
C73-630	MALE AN #4	3/4"	\$5.95
C73-631	MALE AN #6	7/8"	\$6.95
C73-632	MALE AN #8	1"	\$7.95
C73-633	MALE AN #10	1-1/8"	\$8.95
C73-634	MALE AN #12	1-3/8"	\$9.95
C73-635	MALE AN # 16	1-5/8"	\$12.95



COMPUTER
DESIGNED
CONTOURING FOR
HIGHER FLOW
RATES

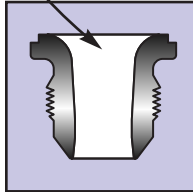

pro-werks

EASY TURN FILL CAP

Positive grip finger notches. Anodized, lightweight, non-vented aluminum cap. Choice of black, red, or blue. Quick-starting coarse threads. Radial squeeze o-ring seal. Female bungs are available as either weld-on type, in aluminum or steel, or as bolt-on type, in anodized aluminum.



Weld-On Bung



Bolt-On Bung

1-5/8" CAP W/ STEEL BUNG (1-1/4-12 THD.)

PART #	DESCRIPTION	PRICE
C73-730	BLACK CAP W/ WELD BUNG	\$22.95
C73-731	RED CAP W/ WELD BUNG	\$22.95
C73-732	BLUE CAP W/ WELD BUNG	\$22.95
C73-745	STEEL WELD BUNG 1-1/2" O.D.	\$6.50

1-5/8" CAP W/ ALUM BUNG (1-1/4-12 THD.)

PART #	DESCRIPTION	PRICE
C73-735	BLACK CAP W/ WELD BUNG	\$22.95
C73-735-B	BLACK CAP W/ BOLT-ON BUNG	\$32.95
C73-736	RED CAP W/ WELD BUNG	\$22.95
C73-736-B	RED CAP W/ BOLT-ON BUNG	\$32.95
C73-737	BLUE CAP W/ WELD BUNG	\$22.95
C73-737-B	BLUE CAP W/ BOLT-ON BUNG	\$32.95
C73-746	BOLT-ON ALUM BUNG	\$16.50
C73-747	ALUM WELD BUNG 1-5/8" O.D.	\$6.50

2" CAP W/ STEEL BUNG (1-1/2-12 THD.)

PART #	DESCRIPTION	PRICE
C73-750	BLACK CAP W/ WELD BUNG	\$24.95
C73-751	RED CAP W/ WELD BUNG	\$24.95
C73-752	BLUE CAP W/ WELD BUNG	\$24.95
C73-765	STEEL WELD BUNG 1-3/4" O.D.	\$6.50

2" CAP W/ ALUM BUNG (1-1/2-12 THD.)

PART #	DESCRIPTION	PRICE
C73-755	BLACK CAP W/ WELD BUNG	\$24.95
C73-755-B	BLACK CAP W/ BOLT-ON BUNG	\$34.95
C73-756	RED CAP W/ WELD BUNG	\$24.95
C73-756-B	RED CAP W/ BOLT-ON BUNG	\$34.95
C73-757	BLUE CAP W/ WELD BUNG	\$24.95
C73-757-B	BLUE CAP W/ BOLT-ON BUNG	\$34.95
C73-766	BOLT-ON ALUM BUNG	\$16.50
C73-767	ALUM WELD BUNG 2" O.D.	\$6.50

2-3/4" CAP W/ STEEL BUNG (2-1/4-10 THD.)

PART #	DESCRIPTION	PRICE
C73-770	BLACK CAP W/ WELD BUNG	\$29.95
C73-771	RED CAP W/ WELD BUNG	\$29.95
C73-772	BLUE CAP W/ WELD BUNG	\$29.95
C73-785	STEEL WELD BUNG 2-3/4" O.D.	\$8.95

2-3/4" CAP W/ ALUM BUNG (2-1/4-10 THD.)

PART #	DESCRIPTION	PRICE
C73-775	BLACK CAP W/ WELD BUNG	\$29.95
C73-775-B	BLACK CAP W/ BOLT-ON BUNG	\$39.95
C73-776	RED CAP W/ WELD BUNG	\$29.95
C73-776-B	RED CAP W/ BOLT-ON BUNG	\$39.95
C73-777	BLUE CAP W/ WELD BUNG	\$29.95
C73-777-B	BLUE CAP W/ BOLT-ON BUNG	\$39.95
C73-786	BOLT-ON ALUM BUNG	\$18.95
C73-787	ALUM WELD BUNG 2-3/4" O.D.	\$8.95



koni

Koni has been long recognized as the leader in adjustable damper technology. Their close tolerance shocks are 100% dyno tested, fully adjustable, and are tailor-made for race car or special driving conditions. Get maximum performance for every

track and tire condition by tuning your suspension for optimal performance with Koni Shocks. Our professional staff will help select the best shock for your car's racing requirements.



Why KONI SPA-1? The new Koni SPA-1 series shock absorber (for drag racing only) is a complete departure from the "90/10" thinking which is no longer effective in modern drag race competition. The old thinking was to allow the vehicle front end to rise quickly and stay there to promote as much weight transfer as possible to the rear wheels. This was achieved by virtually no rebound forces ("10") and a great deal of bump forces ("90"). This massive amount of bump force was supposed to hold the front suspension up to maintain that "bite." Only one problem. That nose-in-the-air attitude trapped huge volumes of air which ruined any attempt at aerodynamics so E.T.'s were not as good as they could have been. Koni SPA-1 series shocks deal with this in several ways. First they use virtually no bump (compression) dampening. Why? To allow the front-end to settle quicker, restoring the nose down attitude that is so essential for cleaner air flow. Second, the rebound (extension) forces are velocity sensitive; that is, they increase at a rate directly proportionate to piston speed.

HOW TO DETERMINE THE CORRECT SHOCK ABSORBER LENGTH

Observe the following three guidelines when determining the correct shock absorber length for your vehicle.

1) Preparing the car:

Place the car body on a level surface and remove springs, shock absorbers, bump rubbers, and sway bar(s).

2) Determining the Maximum Length:

Raise the car body until the tires are lifted off the ground. Take careful note of which component of the suspension is limiting the suspension from traveling further. Raise the tire enough to prevent that suspension component from binding. Measure between the center of the upper and lower shock mounting points. This gives you the desired maximum length shock.

3) Determining the Minimum Length:

Lower the car to the point at which the tub just touches on the pavement, or a tire just touches on the inside of the fender well, or until some other suspension component uses up all its available travel. Measure between the center of the upper and lower shock mounting points. Now select a KONI shock with a minimum which is shorter than your measured minimum suspension length. By choosing a slightly shorter shock you protect the shock from bottoming out and causing internal damage.

HOW TO DETERMINE SPRING RATE

1) Determining Travel:

It is recommended that there be approximately 3" of compression travel available (including the bumpstop). This means the chassis must be supported by a spring rate that will allow the chassis to be supported 3" upward from the bottoming position.

2) Determining the Vehicle Sprung Weight:

Establish front and rear weight of the vehicle. Establish unsprung weight. This is the weight not supported by the springs. i.e., tires, wheels, wheelie bars, brakes, and 1/2 of the weight of the shock, spring, driveline, and ladder bar or four link. 1/2 the weight is used for some components because their weights are equally shared between sprung and unsprung weight. Determine sprung weight, that is the weight of the vehicle less the unsprung weight.

3) Determining Spring Rate:

Divide the rear sprung weight by 2 to determine the load for each rear corner. Divide the front sprung weight by 2 to determine the load for each front corner. If the load for the rear corners is 330 lbs. each (660 lbs./2 = 330 lbs.) then divide the 330 lbs. by the compression travel needed and you arrive at the base spring rate of 110 lbs. per inch. Ex: 330 lbs./3" compression travel = 110 lbs. spring rate.



80 SERIES SHOCK SINGLE ADJUSTABLE

This steel-bodied coil over is for use with coil springs. This rebound adjustable damper features SPA-1 valving and includes an adjustable spring platform, which accepts a 2 1/2" ID spring. The inside bore of the rubber-mounted bushings is 1/2" ID.



PART #	MAX	MIN	STROKE	SPRING LENGTH REQUIRED	PRICE
80-2650SPA-1	15.71"	10.63"	5.08"	12"	\$114.30/EA

PART #	DESCRIPTION	PRICE
70-29-01-230-0	REPL. UPPER SPRING SEAT	\$38.64
70-29-11-246-0	REPL. LOWER SPRING SEAT	\$42.67
70-29-13-002-0	REPL. LOCK RING	\$28.38

8216 SERIES SHOCK SINGLE EXTERNAL ADJUSTABLE

New aluminum construction with externally adjustable rebound control. Features SPA-1 valving adjustable spring platform and accepts 2 1/2" inside diameter spring. The inside bore of the bearings supplied is 1/2" ID.



External Rebound Adjuster



PART #	MAX	MIN	STROKE	SPRING LENGTH REQUIRED	PRICE
8216-1906SPA-1	15.59"	10.98"	4.61"	12"	\$184.15/EA
8216-1907SPA-1	17.17"	11.73"	5.44"	12"	\$184.15/EA
8216-1908SPA-1	19.13"	12.76"	6.37"	14"	\$184.15/EA

PART #	DESCRIPTION	PRICE
70-29-01-119-0	REPL. UPPER SPRING SEAT	\$35.59
70-29-11-129-0	REPL. LOWER SPRING SEAT	\$41.69
71-29-13-011-0	REPL. LOCK RING	\$40.08
14-25-50-00-13	REPL. 1/2" BEARING	\$14.00

8216 SERIES SINGLE EXTERNAL ADJUSTABLE - FRONT

Also available in this shorter version, designed for front suspension applications. Accepts all the same replacement parts as other 8216 shocks.



External Rebound Adjuster



PART #	MAX	MIN	STROKE	SPRING LENGTH REQUIRED	PRICE
8216-2027	11.26"	8.74"	2.52"	7"	\$184.15/EA

8212 SERIES SHOCK DUAL EXTERNAL ADJUSTABLE

Due to its unique valving and wide range of adjustment (both rebound and compression) this series of Koni SPA-1 dampers is adaptable to satisfy many suspension requirements. All aluminum construction with adjustable spring platform accepts a 2 1/2" inside diameter spring. The inside bore of the bearings supplied is 1/2" I.D.



External Rebound Adjuster



External Compression Adjuster



PART #	MAX	MIN	STROKE	SPRING LENGTH REQUIRED	PRICE
8212-1121SPA-1	15.88"	10.75"	5.13"	12"	\$349.25/EA
8212-1126SPA-1	17.50"	11.50"	6"	12"	\$349.25/EA
8212-1123SPA-1	19.50"	12.50"	7"	14"	\$349.25/EA

PART #	DESCRIPTION	PRICE
70-29-01-121-0	REPL. UPPER SPRING SEAT	\$15.20
8212-29-129	REPL. LOWER SPRING SEAT	\$17.50
8212-29-011	REPL. LOCK RING	\$17.50
15-29-04-003-0	NYLON 2.25" TO 2.5" ADAPTER	\$2.19
1425-50-00-13	REPL. 1/2" BEARING	\$14.00

MINI KONI'S

Externally adjustable compression and rebound, these chrome plated Koni's are ideal for lightweight applications. 3 position adjustable spring perch, with external adjustable valving. Includes spanner wrench.



External Adjustable Valving



PART #	MAX	MIN	STROKE	SPRING LENGTH REQUIRED	PRICE
C32-102*	12-9/16"	8-11/16"	3-7/8"	8-1/2"	\$145.80/EA

* With SP1 Valving

MINI SPRING & BILLET TOPS

Billet spring tops are recommended when using springs on Mini Koni's. Springs are 1.70" ID.



PART #	DESCRIPTION	PRICE
235-22/30/39	MINI SPRING	\$37.80/EA
C32-115	BILLET SPRING TOPS	\$32.95/PR



SPANNER WRENCH

Universal design adjusts most popular brands of coil-over shocks.

PART #	DESCRIPTION	PRICE
C72-001	SPANNER WRENCH	\$22.95



REPLACEMENT PARTS

See individual listings by each shock.



eibach

For over 50 years, Eibach has been the spring of choice for racers who demand the best. Found in all types of motorsports, Eibach springs are made from the highest quality materials and wound on Wafio machines - the most accurate CNC winding

machines in the industry. With plenty of sizes to choose from, you get the best spring technology at the lightest possible weight. Better performance, traction control, and balance are what you'll get with Eibach.



The finest coil-over spring in the industry. Quality chrome silicone wire is flat ground to equal length and is powder coated for a lasting finish. Available in many spring rates and each spring is individually marked for easy identification. All listed springs are 2 1/2" ID



7" FREE LENGTH

PART #	SPRING RATE	PRICE
0700.250.0300	300#	\$45.50
0700.250.0350	350#	\$45.50
0700.250.0400	400#	\$45.50
0700.250.0450	450#	\$45.50
0700.250.0500	500#	\$45.50



Precision flat ground.

14" FREE LENGTH

PART #	SPRING RATE	PRICE
1400.250.0100	100#	\$45.50
1400.250.0110	110#	\$45.50
1400.250.0120	120#	\$45.50
1400.250.0125	125#	\$45.50
1400.250.0130	130#	\$45.50
1400.250.0140	140#	\$45.50
1400.250.0150	150#	\$45.50
1400.250.0165	165#	\$45.50
1400.250.0175	175#	\$45.50
1400.250.0185	185#	\$45.50
1400.250.0200	200#	\$48.10
1400.250.0225	225#	\$48.10
1400.250.0250	250#	\$48.10
1400.250.0275	275#	\$48.10
1400.250.0300	300#	\$48.10
1400.250.0350	350#	\$48.10
1400.250.0400	400#	\$48.10

12" FREE LENGTH

PART #	SPRING RATE	PRICE
1200.250.0080	80#	\$45.50
1200.250.0090	90#	\$45.50
1200.250.0100	100#	\$45.50
1200.250.0110	110#	\$45.50
1200.250.0125	125#	\$45.50
1200.250.0130	130#	\$45.50
1200.250.0140	140#	\$45.50
1200.250.0150	150#	\$45.50
1200.250.0165	165#	\$45.50
1200.250.0175	175#	\$45.50
1200.250.0185	185#	\$45.50
1200.250.0200	200#	\$48.10
1200.250.0225	225#	\$48.10
1200.250.0250	250#	\$48.10
1200.250.0275	275#	\$48.10
1200.250.0300	300#	\$48.10
1200.250.0325	325#	\$48.10
1200.250.0350	350#	\$48.10
1200.250.0375	375#	\$48.10
1200.250.0400	400#	\$48.10
1200.250.0425	425#	\$48.10
1200.250.0450	450#	\$48.10

eibach

SPRING BEARING

Allows for easy spring adjustment. Fits any shock/ spring combination using 2-1/2" I.D.springs.

PART #	DESCRIPTION	PRICE
C72-060	2-1/2" I.D. (1 BEARING & 2 RACES)	\$24.95



wilwood

Wilwood Disc Brakes have been the industry leader in high performance brake systems for over 20 years. Developed on sophisticated computer programs and tested on Wilwood's specialized brake dyno, Wilwood brakes provide lightweight,

reliable braking for every race car application. We carry over 200 different brake kits for easy, bolt-on installation and have their entire range of individual braking components.



BILLET DYNALITE REAR AXLE KIT

This kit uses one Billet Dynalite caliper per wheel and is designed for cars with four wheel brakes. For dragsters or other cars that rely on rear brakes only, a dual caliper kit is recommended. All kits are for .500" wheel studs, unless otherwise noted, and feature three 5-bolt patterns 4 1/2", 4 3/4", and 5" bolt circle.



Shown with optional drilled rotors. Add "D" to end of kit part number for this option. Additional cost is \$21.84/ set.

PART #	DESCRIPTION	OFFSET	NOTES	PRICE
140-3259-B	8-1/4" & 9-1/4" MOPAR (STOCK BEARING)	2.62"		\$440.84
140-3260-B	8-3/4" & 9-3/4" MOPAR (STOCK BEARING)	2.36"		\$440.84
140-0263-B	12 BOLT CHEVY (STOCK "C" CLIP ONLY)	2.91"	(1)	\$440.84
140-4545-B	12 BOLT CHEVY (FOR "C" CLIP ELIMINATOR)	2.91"	(1)	\$440.84
140-0262-B	SMALL BEARING FORD	2.66"		\$440.84
140-0261-B	BIG BEARING FORD	2.36"		\$440.84
140-3623-B	BIG BEARING FORD	2.50"		\$440.84
140-2119-B	BIG BEARING FORD (NEW STYLE)	2.50"		\$440.84
140-0265-B	LAMB/MARK WILLIAMS	2.81"		\$440.84
140-5348-B	LAMB/MARK WILLIAMS (FOR .690" STUDS)	2.81"		\$440.84
140-0260-B	8-3/4" MOPAR/DANA 60 (GREEN BEARING)	2.36"		\$440.84
140-5255-B	8-3/4" MOPAR/DANA 60 (GREEN BEARING-SNAP RING)	2.36"		\$440.84
140-0264-B	OLDSMOBILE/PONTIAC	2.91"		\$440.84
140-5349-B	OLDSMOBILE/PONTIAC (FOR .690" STUDS)	2.91"		\$440.84

(1) Kits fit the small bearing 12 bolt housings used in Camaros, Chevelles, and Novas. It will also fit some 10 bolt housings and rear axles used in other GM cars. This kit will not fit the large bearing housings used in full size GM cars and light trucks

KITS INCLUDE: Calipers, brake pads, rotors, hats, brackets, and all mounting hardware.

REPLACEMENT REAR ROTOR

We stock all the replacement parts to keep your Wilwood brake system stopping. Replacement rear rotors are 11.44" dia. x .35" thick.

PART #	DESCRIPTION	PRICE
160-0201	SOLID REAR ROTOR	\$77.44/EA
160-1601	DRILLED REAR ROTOR	\$96.95/EA



TECH TIP

Custom built or narrowed rears may use axle bearings and housing flange bolt patterns different from the original equipment. Consult the rear housing flange chart (next page) to identify the correct housing flange and measure the axle flange offset accurately. Brake kit orders must be based on housing flange and axle flange offset, not the make of the rear end center section.

HOUSING FLANGE IDENTIFICATION CHART

It Is Important To Properly Identify The Correct Rear Axle Brake Kit For Each Specific Application

To order the correct Wilwood Rear Axle Brake kit for each application, refer to the chart to the right to determine the exact housing flange and axle flange-to-housing flange dimensions. Check the following measurements on the rear end assembly: outside bearing diameter, housing flange, stud pattern, bolt circle on axle flange, and dimension from face of axle to face of housing flange (see Axle Flange Cross Section diagram in the margin to the right). These measurements are critical to ensure proper alignment of the rotor to the caliper and should match the offset dimension shown in the specific kit's application chart. Custom built or narrowed rears may use axle bearings and housing flange bolt patterns different from the original equipment. Consult the rear housing flange chart on this page to identify the correct housing flange and measure the axle flange offset accurately. Brake kit orders must be based on housing flange and axle flange offset, not the make of rear end center section. It is critical to correctly measure the dimension from the face of the axle to the face of the housing flange. Match this measurement to the offset dimension on the application chart to find the correct kit for your vehicle.

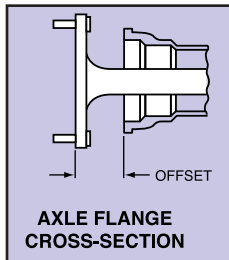

COMMON AXLE HOUSING ENDS

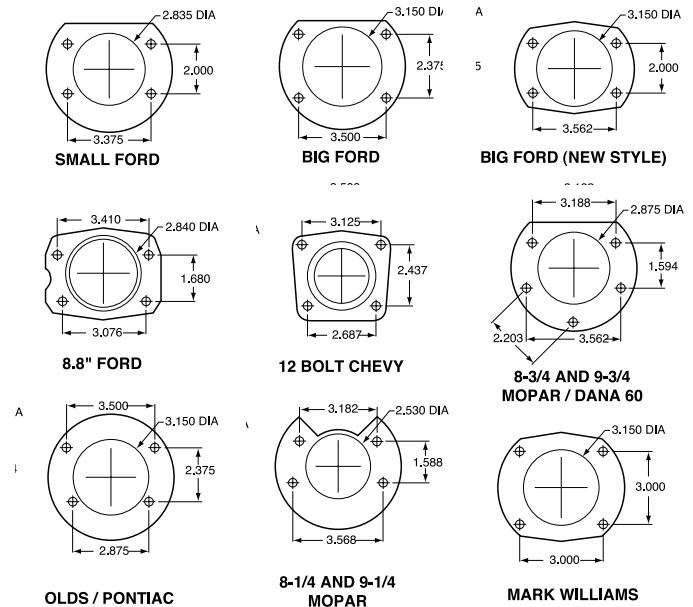

CALIPER MOUNT BRACKETS

Replacement caliper mount brackets for rear drag kits. Sold in pairs.



PART #	DESCRIPTION	PRICE
230-0204	CALIPER BOLT KIT (4)	\$7.22

PART #	FOR KIT	PRICE
249-3891/92	140-3259 B	\$72.78
249-3441/42	140-3260 B	\$134.02
249-0252 L/R	140-0263 B	\$58.19
249-4541/42	140-4545 B	\$58.19
249-0251 L/R	140-0262 B	\$58.19
249-0250 L/R*	140-0261 B	\$58.19
	140-3623 B	
249-2120/21	140-2119 B	\$58.19
249-0992 L/R*	140-0265 B	\$87.36
	140-5348 B	
249-3981/82	140-0260 B	\$72.78
249-5253/54	140-5255 B	\$72.78
249-0254/55*	140-0264 B	\$58.19
	140-5349 B	

*This part # fits multiple kits.

WHEEL STUD

Compatible with front and rear disc brake kits. 1/2"-20 x 3" long.

PART #	DESCRIPTION	PRICE
230-0921	WHEEL STUD	\$2.63/EA



DRILLED ROTOR HAT

4-1/2", 4-3/4" & 5" bolt circles with 1/2" holes.



PART #	DESCRIPTION	PRICE
170-0764	1.41" OFFSET	\$77.31/EA
170-0317	1.59" OFFSET	\$77.31/EA
170-0259	1.71" OFFSET	\$77.31/EA
170-0208	1.96" OFFSET	\$77.31/EA

BLANK ROTOR HAT

Undrilled for custom bolt pattern applications.



PART #	DESCRIPTION	PRICE
171-3757	1.41" OFFSET	\$77.31/EA
171-3755	1.59" OFFSET	\$77.31/EA
171-3754	1.71" OFFSET	\$77.31/EA
171-3756	1.77" OFFSET	\$77.31/EA
171-3753	1.96" OFFSET	\$77.31/EA

DUAL BILLET DYNALITE REAR AXLE KIT

Dual Dynalite Rear Kit uses two calipers per wheel to provide the extra braking power needed for fast dragsters and other cars that rely mainly on rear brakes for stopping power. If the current single caliper system is plagued with excessive component wear from heat or marginal stopping power, a dual caliper system is the best choice. Dual caliper rear systems will provide confident braking and extended component life from reduced stress and lower operating temperatures at the calipers, brake pads, rotors, and hats. Dual Billet Dynalite systems use the same quality components as the single Billet Dynalite kits and provide unmatched performance with the lowest possible rotating and unsprung weight.



KITS INCLUDE: Two calipers, brake pads, rotors, dual mount brackets, all mounting hardware. Shown with optional drilled rotors, add "D" to end of kit part number for this option, additional cost is \$21.84/set.

PART #	DESCRIPTION	OFFSET	PRICE
140-5367-B	BIG FORD (FOR .500" STUDS)	2.36"	\$725.33
140-5366-B	LAMB/MARK WILLIAMS REAR END (FOR .500" STUDS)	2.81"	\$725.33
140-5369-B	LAMB/MARK WILLIAMS REAR END (FOR .690" STUDS)	2.81"	\$725.33
140-5365-B	OLDSMOBILE/PONTIAC (FOR .500" STUDS)	2.91"	\$725.33
140-5368-B	OLDSMOBILE/PONTIAC (FOR .690" STUDS)	2.91"	\$725.33

INSTALLATION NOTE: Dual caliper kits require more master cylinder volume than single caliper kits to work properly.

DUAL CALIPER CONVERSION KIT

This conversion kit includes special brackets, a pair of Dynalite II or Billet Dynalite calipers (specify type required when ordering), and a set of Polymatrix Brake Pads to update existing Wilwood single caliper rear systems.

PART #	DESCRIPTION	PRICE
140-5494	BIG FORD (FOR 3.150" BEARING DIAMETER)	\$320.92
140-5493	LAMB/MARK WILLIAMS REAR END	\$320.92
140-5492	OLDSMOBILE/PONTIAC	\$320.92

REAR HEAVY DUTY PRO SERIES BRAKE KIT

Pro Series rear brake kits provide absolute braking performance for a wide variety of performance street, custom show, and competition cars. These kits combine the powerful clamping force of the new generation 4 piston Billet Dynalite calipers with the added performance and cooling capacity of competition style vented iron alloy rotors. Kits are available with or without parking brakes and anodized or fully polished for the ultimate finish to your wheel and suspension detail.



Shown with optional polished caliper.

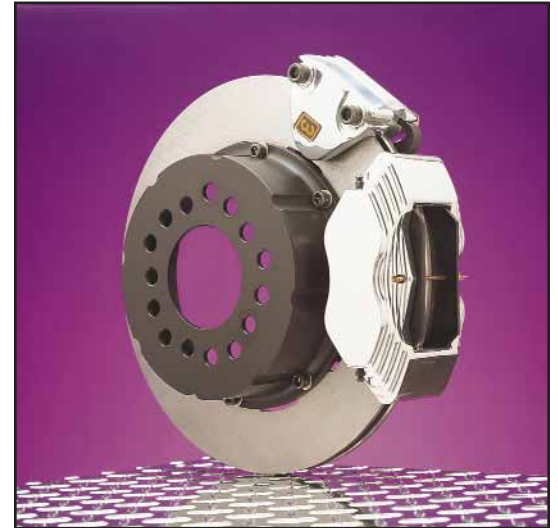

Shown with parking brake and polished caliper option.

KITS INCLUDE: Calipers, brake pads, vented rotors, hats, and mounting hardware.

PART #	DESCRIPTION	OFFSET	NOTES	PRICE	W/ PARKING BRAKE PART #	PRICE
140-2112-B	12 BOLT CHEVY (STOCK "C" CLIP ONLY)	2.91"	(1)	\$514.11	140-2277-B	\$642.90
140-5236-B	12 BOLT CHEVY (FOR "C" CLIP ELIMINATOR)	2.91"	(1)	\$514.11	140-5237-B	\$642.90
140-2113-B	SMALL BEARING FORD	2.66"		\$514.11	140-2275-B	\$642.90
140-2115-B	BIG BEARING FORD	2.36"		\$514.11	140-2274-B	\$642.90
140-2114-B	BIG BEARING FORD	2.54"		\$514.11	N/A	N/A
140-2118-B	BIG BEARING FORD (NEW STYLE)	2.50"		\$514.11	140-2276-B	\$642.90
140-2116-B	MOPAR/DANA 60 (GREEN BEARING ONLY)	2.72"		\$514.11	N/A	N/A
140-2117-B	MOPAR/DANA 60 (GREEN BEARING ONLY)	2.36"		\$514.11	140-2279-B	\$642.90
140-5591-B	MOPAR/DANA 60 (GREEN BEARING-SNAP RING)	2.36"		\$514.11	140-5592-B	\$642.90
140-2783-B	REAR 8.8 MUSTANG (4 LUG)	2.50"		\$514.11	140-2782-B	\$642.90
140-3018-B	REAR 8.8 MUSTANG (5 LUG)	2.50"		\$514.11	140-2949-B	\$642.90
140-2111-B	OLDSMOBILE/PONTIAC	2.91"		\$514.11	140-2278-B	\$642.90

(1) Kit fits the small bearing 12 bolt housings used in Camaros, Chevelles, and Novas. It will also fit some 10 bolt housings and rear axles used in other GM cars. This kit will not fit the large bearing housings used in full size GM cars and light trucks

REPLACEMENT ROTOR

12.19" dia. x .81" thick, eight 5/16" holes on 7.62" bolt circle.

PART #	DESCRIPTION	PRICE
160-5844	REPLACEMENT ROTOR	\$43.19

DIRECT SPINDLE MOUNT FRONT BRAKE KIT

For funny cars and other lightweight drag cars with direct spindle mount front wheels (Hat has 5 holes on 4-3/4" bolt circle). These kits are designed for cars under 2400 lbs. that are also equipped with rear disc brakes. This system combines confident performance with classic styling in a truly compact, weight saving design. Requires welding of mount tabs on spindle for caliper bracket.

KITS INCLUDE: Caliper with brake pads, hats, and rotor bolt kit.



FRONT SPINDLE APPLICATIONS

PART #	DESCRIPTION	PRICE
140-3326-B	ANGLIA, P&S SPINDLE MOUNT	\$481.69

REPLACEMENT FRONT ROTOR

PART #	DESCRIPTION	PRICE
160-0867	SOLID ROTOR	\$77.44
160-1602	DRILLED ROTOR	\$96.95

10" dia. x .25" thick, five 3/8" holes on 5" bolt circle

Add "D" to end of kit part number for drilled rotor option.
Additional cost is \$21.84/set.

FRONT LIGHT DUTY DRAG RACE KIT

Designed for door cars, roadster, and other cars under 2400 lbs. with four wheel disc brakes. Each kit is complete, as listed for its application, saving up to 50 lbs. off the front end.



KITS INCLUDE: Calipers, brake pads, hubs with studs, mounting brackets, and mounting hardware.

FRONT SPINDLE APPLICATIONS

MAKE	YEAR	DISC/DRUM	PART #	NOTES	PRICE
BUICK					
APOLLO	1973-74	DISC/DRUM	140-1016-B		\$516.01
CHEVROLET					
CAMARO	1967-69	DISC/DRUM	140-1016-B		\$516.01
CHEVELLE	1967-72	DISC/DRUM	140-1016-B		\$516.01
CHEVELLE, MODIFIED	1964-66	DRUM	140-1016-B	(1)	\$516.01
CHEVY II/NOVA	1967-74	DISC/DRUM	140-1016-B		\$516.01
CHEVY II, MODIFIED	1964-66	DRUM	140-1016-B	(1)	\$516.01
EL CAMINO	1967-72	DISC/DRUM	140-1016-B		\$516.01
EL CAMINO, MODIFIED	1964-66	DRUM	140-1016-B	(1)	\$516.01
MONTE CARLO	1970-72	DISC/DRUM	140-1016-B		\$516.01
MONZA	1975	DISC/DRUM	140-1038-B	(2)	\$547.16
VEGA	1971-77	DISC/DRUM	140-1038-B	(2)	\$547.16
FORD					
MUSTANG II	1974-78	DRUM	140-1012-B		\$516.01
PINTO	1971-1980	DISC/DRUM	140-1012-B		\$516.01
GMC					
GMC SPIRIT	1971-72	DISC/DRUM	140-1016-B		\$516.01
MERCURY					
BOBCAT	1975-80	DRUM	140-1012-B		\$516.01
OLDSMOBILE					
F-85	1967-72	DISC	140-1016-B		\$516.01
F-85	1970-72	DRUM	140-1016-B	(3)	\$516.01
OMEGA	1973-74	DISC/DRUM	140-1016-B		\$516.01
PONTIAC					
VENTURA II	1971-74	DISC/DRUM	140-1016-B		\$516.01

NOTES

- (1) Requires redrilling and tapping top caliper bracket mounting hole.
- (2) Disc spindles require removal of factory Caliper mounting ears.
- (3) With O.A.I. drum spindle.

10" dia x .32" thick, five 3/8" holes on 3.88" circle.

FRONT MEDIUM DUTY DRAG RACE KIT

More cars are equipped with Wilwood's medium duty front brake kits than all other brands combined. Designed for cars up to 2800 lbs, these kits combine the new generation Billet Dynalite calipers with an innovative design, steel alloy rotor, and an aluminum intermediate rotor plate. This configuration generates big stopping power with minimum weight and maximum reliability against heat distortion. Four wheel disc brakes will provide the ultimate performance. These kits provide major stopping power and can be used with drum brake rears.



Shown with optional drilled rotor.

FRONT HEAVY DUTY PRO SERIES BRAKE KIT

Wilwood's unmatched performance is combined with classic, high tech styling in the ultimate kit for street rods, muscle cars, hot rods, and heavy weight drag cars. These systems stop hard, withstand severe heat, and can save as much as 35 lbs of unsprung and rotating weight over OEM components. For custom show machines, polished caliper kits are also available to catch the eye and win the favor of the most discriminating enthusiasts.



Shown with optional polished caliper.

MAKE	YEAR	DISC/DRUM	MEDIUM PART #	MEDIUM NOTES	MEDIUM PRICE	HEAVY PART #	HEAVY NOTES	HEAVY PRICE
BUICK								
Apollo	1973-74	Disc/Drum	140-1017-B		\$542.84	140-2285-B		\$642.90
Apollo	1975	Disc Br Spndl Only	140-1019-B	(B)	\$542.84	140-3445-B	(4)	\$642.90
Buick, GN, Late	1979-87	Disc	140-1033-B	(B)(D)	\$542.84	140-2508-B	(4) (8)	\$642.90
Century	1973-77	Disc Br Spndl Only	140-1019-B	(B)	\$542.84	140-3445-B	(4)	\$642.90
Century, Late	1979-81	Disc	140-1033-B	(B)(D)	\$542.84	140-2508-B	(4) (8)	\$642.90
Regal	1973-77	Disc Br Spndl Only	140-1019-B	(B)	\$542.84	140-3445-B	(4)	\$642.90
Regal, Late	1979-87	Disc	140-1033-B	(B)(D)	\$542.84	140-2508-B	(4) (8)	\$642.90
Skylark	1975-79	Disc Br Spndl Only	140-1019-B	(B)	\$542.84	140-3445-B	(4)	\$642.90
Special	1967-72	Disc				140-2285-B		\$642.90
Special	1973-74	Disc				140-3445-B	(4)	\$642.90
CHEVROLET								
Blazer, 4x2, 100.5" Wheel Base	1983-90	Disc	140-1033-B	(B)	\$542.84	140-2508-B	(4)	\$642.90
Belair	1955-57	Drum				140-3425-B	(6)	\$642.90
Belair / Biscayne	1959-64	Drum				140-5329-B	(6) (7)	\$642.90
Camaro	1967-69	Disc/Drum	140-1017-B		\$542.84	140-2285-B		\$642.90
Camaro	1982-87	Disc	140-1035-B	(B)	\$542.84	140-2992-B	(4)	\$642.90
Camaro	1970-78	Disc Br Spndl Only	140-1019-B	(B)	\$542.84	140-3445-B	(4)	\$642.90
Camaro, Single Piston Caliper Only	1988-92		140-1035-B	(B)	\$542.84	140-2992-B	(4)	\$642.90
Caprice	1977-78	Disc Br Spndl Only	140-1019-B	(B)	\$542.84	140-3445-B	(4)	\$642.90
Chevelle	1967-72	Disc/Drum	140-1017-B		\$542.84	140-2285-B		\$642.90
Chevelle	1973-77	Disc Br Spndl Only	140-1019-B	(B)	\$542.84	140-3445-B	(4)	\$642.90
Chevelle, Modified	1964-66	Drum	140-1017-B	(F)	\$542.84	140-2285-B	(1)	\$642.90
Chevrolet, Full Size	1977-78	Disc Br Spndl Only	140-1019-B	(B)	\$542.84	140-3445-B	(4)	\$642.90
Chevy II / Nova	1967-74	Disc/Drum	140-1017-B		\$542.84	140-2285-B		\$642.90
Chevy S10	1982-90	Disc	140-1033-B	(B)	\$542.84	140-2508-B	(4)	\$642.90
Chevy II, Modified	1964-66	Drum	140-1017-B	(F)	\$542.84	140-2285-B	(1)	\$642.90
Corvette	1963-64	Drum				140-5329-B	(6) (7)	\$642.90
El Camino	1967-72	Drum	140-1017-B		\$542.84	140-2285-B		\$642.90
El Camino	1973-77	Disc Br Spndl Only	140-1019-B	(B)	\$542.84	140-3445-B	(4)	\$642.90
El Camino, Modified	1964-66	Drum	140-1017-B	(F)	\$542.84	140-2285-B	(1)	\$642.90
El Camino, Late	1979-87	Disc	140-1033-B	(B)(D)	\$542.84	140-2508-B	(4) (8)	\$642.90
Impala	1959-64	Drum				140-5329-B	(6) (7)	\$642.90
Impala, w/11" Rotor	1977-78	Disc Br Spndl Only	140-1019-B	(A)(B)	\$542.84	140-3445-B	(3) (4)	\$642.90
Malibu	1973-77	Disc Br Spndl Only	140-1019-B	(B)	\$542.84	140-3445-B	(4)	\$642.90
Malibu, Late	1979-87	Disc	140-1033-B	(B)(D)	\$542.84	140-2508-B	(4) (8)	\$642.90
Monte Carlo	1970-72	Disc/Drum	140-1017-B		\$542.84	140-2285-B		\$642.90
Monte Carlo	1973-77	Disc Br Spndl Only	140-1019-B	(B)	\$542.84	140-3445-B	(8)	\$642.90
Monte Carlo, Late	1979-88	Disc	140-1033-B	(B)(D)	\$542.84	140-2508-B	(4) (8)	\$642.90
Nova	1975-78	Disc Br Spndl Only	140-1019-B	(B)	\$542.84	140-3445-B	(4) (8)	\$642.90
DODGE								
Challenger	1970-72	Drum	140-2711-B		\$542.84	140-2721-B		\$642.90
Challenger	1970-72	Disc	140-2716-B		\$542.84	140-2726-B		\$642.90
Challenger	1973-74	Disc	140-2719-B	(E)	\$542.84	140-2729-B	(9)	\$642.90
Charger	1966-72	Drum	140-2711-B		\$542.84	140-2721-B		\$642.90
Charger	1966-69	Disc	140-2715-B	(E)	\$542.84	140-2725-B	(9)	\$642.90
Charger	1970-72	Disc	140-2716-B		\$542.84	140-2726-B		\$642.90
Coronet	1965-72	Drum	140-2711-B		\$542.84	140-2721-B		\$642.90

Front Heavy Duty Pro Series Kit Notes

Most kits available with polished or black anodized calipers.

(1) Mid 1965 and earlier models require spindle modifications.

(2) Caliper brackets not included.

(3) Disc spindles with 11" rotor only.

(4) Factory caliper mounting ears and backing plate bolt holes must be modified.

(5) Backing plate mount holes must be redrilled and tapped on disc brake spindles.

(6) Front track width becomes approximately 1" wider per side. 15" disc brake offset wheels required.

(7) Standard brakes only, no Z-11 or HD.

(8) Late spindle uses a torque nut to retain hub and bearing.

(9) Spindle must be modified.

(10) With O.A.I. drum spindle.

	MAKE	YEAR	DISC/DRUM	MEDIUM PART #	MEDIUM NOTES	MEDIUM PRICE	HEAVY PART #	HEAVY NOTES	HEAVY PRICE
DODGE									
	Coronet	1966-69	Disc	140-2715-B	(E)	\$542.84	140-2725-B	(9)	\$642.90
	Coronet	1970-72	Disc	140-2716-B		\$542.84	140-2726-B		\$642.90
	Dart	1963-72	9" Drum	140-2712-B		\$542.84	140-2722-B		\$643.03
	Dart	1965-72	10" Drum	140-2713-B		\$542.84	140-2723-B		\$642.90
	Dart	1965-72	Disc	140-2714-B	(E)	\$542.84	140-2724-B	(9)	\$642.90
	Dart	1973-74	Disc	140-2719-B	(E)	\$542.84	140-2729-B	(9)	\$642.90
	Dodge Pass, except 880 series	1962-64	Drum	140-2711-B		\$542.84	140-2721-B		\$642.90
	Lancer	1961-62	9" Drum	140-2712-B		\$542.84	140-2722-B		\$643.03
	R/T	1967-70	Drum	140-2711-B		\$542.84	140-2721-B		\$642.90
	R/T	1967-69	Disc	140-2715-B	(E)	\$542.84	140-2725-B	(9)	\$642.90
	R/T	1970	Disc	140-2716-B		\$542.84	140-2726-B		\$642.90
FORD									
	Early Ford Passenger, Car Spindle	1937-48		140-1501-B		\$542.84	140-2260-B		\$642.90
	Fairlane	1966-69	Drum	140-4307-B		\$542.84	140-4304-B		\$642.90
	Fairlane	1966-69	Disc	140-4307-B	(C)	\$542.84	140-4304-B	(5)	\$642.90
	Falcon	1965-69	Disc/Drum	140-4307-B	(C)	\$542.84	140-4304-B	(5)	\$642.90
	Mustang, SVO	1984-86	Disc	140-4503-B	(B)	\$542.84			
	Mustang, V8	1987-93		140-4503-B	(B)	\$542.84			
	Mustang II	1974-78	Disc	140-1013-B		\$542.84	140-2129-B		\$642.90
	Mustang V8 Spindle	1965-69	Disc/Drum	140-4307-B	(C)	\$542.84	140-4304-B	(5)	\$642.90
	Mustang Shelby, GT350,GT500	1970	Disc	140-4307-B	(C)	\$542.84	140-4304-B	(5)	\$642.90
	Pinto	1971-80	Disc/Drum	140-1013-B		\$542.84	140-2129-B		\$642.90
	Ranchero	1967-69	Disc/Drum	140-4307-B	(C)	\$542.84	140-4304-B	(5)	\$642.90
	Thunderbird, Turbo Coupe	1987-88	Disc	140-4503-B	(B)	\$542.84			
GMC									
	GMC Sprint	1971-72	Disc/Drum	140-1017-B		\$542.84	140-2285-B		\$642.90
	GMC Sprint	1979-87	Disc	140-1033-B	(B)	\$542.84	140-2508-B	(4)	\$642.90
	GMC Sprint	1973-77	Disc Br Spndl Only	140-1019-B	(B)	\$542.84	140-3445-B	(4)	\$642.90
	Jimmy, 4x2, 100.5" Wheel Base	1983-90	Disc	140-1033-B	(B)	\$542.84	140-2508-B	(4)	\$642.90
	S15, 4x2	1982-90	Disc	140-1033-B	(B)	\$542.84	140-2508-B	(4)	\$642.90
MERCURY									
	Bobcat	1975-80	Disc	140-1013-B		\$542.84	140-2129-B		\$642.90
	Comet	1965-69	Disc/Drum	140-4307-B	(C)	\$542.84	140-4304-B	(5)	\$642.90
	Cougar	1967-69	Disc/Drum	140-4307-B	(C)	\$542.84	140-4304-B	(5)	\$642.90
OLDSMOBILE									
	Cutlass	1973-77	Disc Br Spndl Only	140-1019-B	(B)	\$542.84	140-3445-B	(4)	\$642.90
	Cutlass, Late, Rear Wheel Drive	1979-88		140-1033-B	(B)	\$542.84	140-2508-B	(4) (8)	\$642.90
	F-85	1967-72	Disc	140-1017-B		\$542.84	140-2285-B		\$642.90
	F-85	1970-72	Drum	140-1017-B	(G)	\$542.84	140-2285-B	(10)	\$642.90
	F-85	1973-77	Disc	140-1019-B	(B)	\$542.84	140-3445-B	(4)	\$642.90
	Oldsmobile w/11" Rotor	1977-78	Disc Br Spndl Only	140-1019-B	(A)(B)	\$542.84	140-3445-B	(4)	\$642.90
	Omega	1973-74	Disc/Drum	140-1017-B		\$542.84	140-2285-B		\$642.90
	Omega	1975-78	Disc Br Spndl Only	140-1019-B	(B)	\$542.84	140-3445-B	(4)	\$642.90
PLYMOUTH									
	Barracuda	1964-69	9" Drum	140-2712-B		\$542.84	140-2722-B		\$643.03
	Barracuda	1965-69	10" Drum	140-2713-B		\$542.84	140-2723-B		\$642.90
	Barracuda	1965-69	Disc	140-2714-B	(E)	\$542.84	140-2724-B	(9)	\$642.90
	Barracuda	1970-72	Drum	140-2711-B		\$542.84	140-2721-B		\$642.90
	Barracuda	1970-72	Disc	140-2716-B		\$542.84	140-2726-B		\$642.90
	Barracuda	1973-74	Disc	140-2719-B	(E)	\$542.84	140-2729-B	(9)	\$642.90
	Belvedere	1965-70	Drum	140-2711-B		\$542.84	140-2721-B		\$642.90
	Belvedere	1966-69	Disc	140-2715-B	(E)	\$542.84	140-2725-B	(9)	\$642.90
	Belvedere	1970	Disc	140-2716-B		\$542.84	140-2726-B		\$642.90
	GTX	1967-71	Drum	140-2711-B		\$542.84	140-2721-B		\$642.90
	GTX	1967-69	Disc	140-2715-B	(E)	\$542.84	140-2725-B	(9)	\$642.90
	GTX	1970-71	Disc	140-2716-B		\$542.84	140-2726-B		\$642.90
PLYMOUTH									
	Road Runner	1962-64	Drum	140-2711-B		\$542.84	140-2721-B		\$642.90
	Road Runner	1968-72	Drum	140-2711-B		\$542.84	140-2721-B		\$642.90
	Road Runner	1968-69	Disc	140-2715-B	(E)	\$542.84	140-2725-B	(9)	\$642.90
	Road Runner	1970-72	Disc	140-2716-B		\$542.84	140-2726-B		\$642.90
	Satellite	1965-72	Drum	140-2711-B		\$542.84	140-2721-B		\$642.90
	Satellite	1966-69	Disc	140-2715-B	(E)	\$542.84	140-2725-B	(9)	\$642.90
	Satellite	1970-72	Disc	140-2716-B		\$542.84	140-2726-B		\$642.90
	Superbee	1968-70	Drum	140-2711-B		\$542.84	140-2721-B		\$642.90
	Superbee	1968-69	Disc	140-2715-B	(E)	\$542.84	140-2725-B	(9)	\$642.90
	Superbee	1970	Disc	140-2716-B		\$542.84	140-2726-B		\$642.90
	Valiant	1960-72	9" Drum	140-2712-B		\$542.84	140-2722-B		\$643.03
	Valiant	1965-72	10" Drum	140-2713-B		\$542.84	140-2723-B		\$642.90
	Valiant	1965-72	Disc	140-2714-B	(E)	\$542.84	140-2724-B	(9)	\$642.90
	Valiant	1973-74		140-2719-B	(E)	\$542.84	140-2729-B	(9)	\$642.90
PONTIAC									
	Bonneville	1982-86	Disc	140-1033-B	(B)	\$542.84	140-2508-B	(4)	\$642.90
	Firebird	1982-87	Disc	140-1035-B	(B)	\$542.84	140-2992-B	(4)	\$642.90
	Firebird	1970-78	Disc Br Spndl Only	140-1019-B	(B)	\$542.84	140-3445-B	(4)	\$642.90
	Firebird, Single Piston Caliper Only	1988-92		140-1035-B	(B)	\$542.84	140-2992-B	(4)	\$642.90
	Grand Prix	1973-77	Disc Br Spndl Only	140-1019-B	(B)	\$542.84	140-3445-B	(4)	\$642.90
	Grand Prix, Late	1979-87	Disc	140-1033-B	(B)(D)	\$542.84	140-2508-B	(4) (8)	\$642.90
	Lemans	1973-77	Disc	140-1019-B	(B)	\$542.84	140-3445-B	(4)	\$642.90
	Lemans, Late	1979-81	Disc Br Spndl Only	140-1033-B	(B)(D)	\$542.84	140-2508-B	(4) (8)	\$642.90
	Phoenix	1977-78	Disc Br Spndl Only	140-1019-B	(B)	\$542.84	140-3445-B	(4)	\$642.90
	Pontiac Full Size, w/11" Rotor	1977-78	Disc Br Spndl Only	140-1019-B	(A)(B)	\$542.84	140-3445-B	(3) (4)	\$642.90
	Tempest	1973-77	Disc	140-1019-B	(B)	\$542.84	140-3445-B	(4)	\$642.90
	Ventura II	1971-74	Disc/Drum	140-1017-B		\$542.84	140-2285-B		\$642.90
	Ventura II	1975-77	Disc Br Spndl Only	140-1019-B	(B)	\$542.84	140-3445-B	(4)	\$642.90

Front Medium Duty Drag Race Kit Notes

Most kits available with polished or black anodized

(A) Disc spindles with 11" rotor only.

(B) Factory caliper mounting ears and backing plate bolt holes must be modified.

(C) Backing plate mount holes must be redrilled and tapped on disc brake spindles.

(D) Late spindle uses a torque nut to retain hub and bearing.

(E) Spindle must be modified.

(F) Mid 1965 and earlier require spindle modifications.

(G) With O.A.I. drum spindle.

BILLET SPOT CALIPER

Single action floating caliper, precision computer machined from billet aluminum. Only 1.2 lbs. 3-5/16" bolt centers. Accepts up to .38" thick rotors, universal application, right or left.



PART #	DESCRIPTION	PRICE
120-1064	BILLET CALIPER	\$97.49
150-1251K	TAN ROUND PADS SOFT (4)	\$23.80
230-1112	SPOT PAD SCREW	\$0.44

MECHANICAL SPOT CALIPER

Features single piston floating housing which permits use in small, compact applications. Ideal for parking brake. Mechanical cam-actuated lever with two settings for adjustment. Only 1.6 lbs. Pads included. 2.95" mount centers. Accepts up to .50" thick rotors.



Right side shown.

PART #	DESCRIPTION	PRICE
120-2373	MECHANICAL CALIPER - RIGHT	\$57.75
120-2374	MECHANICAL CALIPER - LEFT	\$57.75
150-2420	TAN PAD	\$5.92/EA

DYNALITE SINGLE FLOATER

Single piston housing of billet aluminum permits use in small, compact applications. Only 1.4 lbs. Open back allows for quick pad change - accepts Dynalite Single pads. 3.28" bolt centers. Universal application, right or left.



PART #	DESCRIPTION	PRICE
120-2498	DYNALITE SINGLE FLOATER - FITS 1/4" ROTOR	\$97.49
120-3277	DYNALITE SINGLE FLOATER - FITS 3/8" ROTOR	\$97.49

BILLET DYNALITE SINGLE

Dual action 2-piston caliper has the lowest possible weight, only 1.4 lbs. Stainless steel pistons for a 300% reduction in heat transfer. Accepts 6" to 13" dia. rotors up to .38" thick. Universal application, right or left.



PART #	DESCRIPTION	PRICE
120-4060	CALIPER 3.750" BOLT PATTERN	\$86.05
120-4062	CALIPER 3.250" BOLT PATTERN	\$86.05

DYNALITE SINGLE PADS

Not included with calipers.

PART #	DESCRIPTION	PRICE
150-3671-K	PURPLE (ALUM ONLY) (4)	\$38.36
15D-4330-K	BLK (POLYMATRIX) STICKY (4)	\$35.00
15T-5910-K	TAN SOFT (4)	\$32.07
150-2390-K	GREEN (GATOR) MED (4)	\$41.15

DYNALITE II

Weighing only 2.7 lbs., this compact design 4-piston caliper is ideal for a wide range of braking applications. Black anodized aluminum with stainless steel pistons, accepts 9" to 15" dia. rotors, 5.25" bolt pattern with 1/8" NPT inlet.



Right side shown.

PART #	DESCRIPTION	ROTOR THICKNESS	PRICE
120-1051 L	CALIPER - LEFT	.38"	\$107.18
120-1051 R	CALIPER - RIGHT	.38"	\$107.18
120-1052 L	CALIPER - LEFT	.81"	\$107.18
120-1052 R	CALIPER - RIGHT	.81"	\$107.18

BILLET DYNALITE

Powerful and compact, 4-piston rigid design produces incredible brake torque at minimum weight -2.5 lbs., universal with multiple bleeders. May be used on right or left side. Accepts 9" to 15" dia rotors, 5.25" bolt pattern with 1/8" NPT inlet.



PART #	DESCRIPTION	ROTOR THICKNESS	PRICE
120-4993	CALIPER	.38"	\$128.61
120-4997	CALIPER	.81"	\$128.61

4 PISTON CALIPER PADS

Not included with caliper.

PART #	DESCRIPTION	PRICE
15D-4331-K	BLK (POLYMATRIX) STICKY (4)	\$43.75
15T-5911-K	TAN SOFT (4)	\$40.82
150-2391-K	GREEN (GATOR) MED (4)	\$59.85
150-4153-K	TAN SOFT (4) (NOTCHED FOR BRIDGE BOLT)	\$60.20
15D-4336-K	BLK (POLYMATRIX) STICKY (4) (NOTCHED FOR BRIDGE BOLT)	\$53.95

BRAKE PADS

FRICION PAD TECHNICAL INFORMATION

Wilwood brake pads are available in a wide variety of compositions to meet the high performance demands of racing disc brake systems. Dimensionally, they are also inter-changeable with other caliper manufacturers such as CNC, JFZ, etc.

TAN PAD: instant pedal response, hi-coefficient of friction at low temperature range (low dust).

GATOR PAD: semi-metallic compound is aggressive. Hi co-efficient of friction in low to medium temperature range.

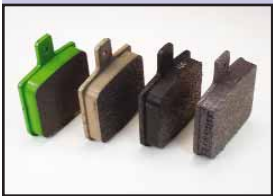

BLACK PAD: polymatrix pad, widest operating range, sticky pad provides low wear rate on rotor.

PURPLE PAD: for aluminum rotors, only available for Dynalite Single.



Dynalite



Dynalite Single



Billet Spot

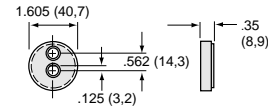
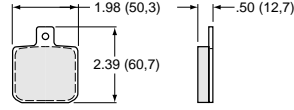
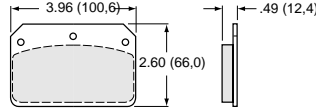

IMPORTANT TECH TIP

PAD BEDDING

Friction pads will offer increased performance, wear longer, create less dust, and reduce rotor wear when properly bedded in.

PAD BEDDING PROCEDURE

Pump brakes at low speed to assure proper operation. On race track or other safe location, make a series of hard stops until some brake fade is experienced. Allow brakes to cool completely, this process will burnish the brake pads, offering maximum performance.

PART #	DESCRIPTION	DESCRIPTION	PRICE
150-1251K	BILLET SPOT	TAN ROUND PADS SOFT (4)	\$23.80
150-2420	MECHANICAL SPOT	TAN PAD	\$5.92/EA
150-3671-K	DYNALITE SINGLE	PURPLE (ALUM ONLY) (4)	\$38.36
15D-4330-K	DYNALITE SINGLE	BLK (POLYMATRIX) STICKY (4)	\$35.00
15T-5910-K	DYNALITE SINGLE	TAN SOFT (4)	\$32.07
150-2390-K	DYNALITE SINGLE	GREEN (GATOR) MED (4)	\$41.15
15D-4331-K	DYNALITE (4-PISTON)	BLK (POLYMATRIX) STICKY (4)	\$43.75
15T-5911-K	DYNALITE (4-PISTON)	TAN SOFT (4)	\$40.82
150-2391-K	DYNALITE (4-PISTON)	GREEN (GATOR) MED (4)	\$59.85
150-4153-K	DYNALITE (4-PISTON)	TAN SOFT (4) (NOTCHED FOR BRIDGE BOLT)	\$60.20
15D-4336-K	DYNALITE (4-PISTON)	BLK (POLYMATRIX) STICKY (4) (NOTCHED FOR BRIDGE BOLT)	\$53.95

CALIPER REPLACEMENT PARTS

We stock all the necessary replacement parts to rebuild Wilwood calipers.



PART #	DESCRIPTION	PRICE
130-0053	ROUND O RINGS 1.38" DIA (4)	\$8.10
130-0047	ROUND O RINGS 1.75" DIA (4)	\$8.10
130-2658	SQUARE O RINGS 1.38" DIA (4)	\$8.10
130-4346	SQUARE O RINGS 1.62" DIA (4)	\$8.10
130-2655	SQUARE O RINGS 1.75" DIA (4)	\$8.10
180-0054	COTTER PINS 1/8" X 2.5" (10)	\$4.74
180-0055	COTTER PINS 1/8" X 3" (10)	\$4.74
180-0056	COTTER PINS 1/8" X 3.5" (10)	\$4.74
190-3651	CROSS OVER TUBE FOR DLS (4)	\$10.50
190-3650	CROSS OVER TUBE FOR DLII (4) (.38" ROTOR WIDTH)	\$10.50
190-3650-A	CROSS OVER TUBE FOR DLII (4) (.810" ROTOR WIDTH)	\$10.50
180-3862	PAD RETAINER PINS (4) (.134" X 2.4")	\$10.13
200-1117	STNLS PISTON 1.38" DIA DLII	\$8.39
200-1118	STNLS PISTON 1.75" DIA DLII	\$8.39
220-0627	BLEEDER SCREWS (4)	\$8.67

HI-TEMP BRAKE FLUID

Specially formulated Wilwood brake fluid lubricates and cleans internal brake components. 570 degree dry boiling point exceeds DOT 3 and DOT 4 requirements by over 100 degrees.



PART #	DESCRIPTION	PRICE
290-0632	12 oz.	\$6.20
290-2210	6-pk.	\$32.81

BRAKE GAUGE

0-1500 PSI easy read gauge allows for quick line pressure reading and accurate master cylinder and brake bias set up.



PART #	DESCRIPTION	PRICE
260-0966	BRAKE GAUGE	\$65.63

Also see our Auto Meter section for dash mount style.

ADJUSTABLE PROPORTIONING VALVE

Fast and effective method to positively adjust front and rear brakes. Specifically designed to correct braking imbalance. Ideal for disc and drum brakes.



PART #	DESCRIPTION	PRICE
260-2220	KNOB TYPE	\$41.99
260-2400	LEVER TYPE	\$79.49

LARGE RESERVOIR MASTER CYLINDER

With total fluid capacity of 8.22 oz., this aluminum master cylinder is light and keeps fluid cool. A stiffer piston spring provides improved pedal feel, features 1-7/16" stroke. Includes Bellows-type gasket and quick release formed steel lid. 5/16"-24 threaded pushrod.

Face Mt. 2-1/4" c-c
Side Mt. 3" c-c
1/8" NPT Outlet Port



PART #	DESCRIPTION	PRICE
260-6764	3/4" DIA. MASTER CYLINDER	\$52.49
260-6765	7/8" DIA. MASTER CYLINDER	\$52.49
260-6766	1" DIA. MASTER CYLINDER	\$52.49
260-6898	REBUILD KIT FOR 3/4"	\$20.93
260-6899	REBUILD KIT FOR 7/8"	\$20.93
260-6900	REBUILD KIT FOR 1"	\$20.93
330-6724	REPL LID	\$10.13
210-6725	BELLOWS TYPE GSMT	\$5.76

TANDEM MASTER CYLINDER

Aluminum housing with large plastic reservoir provides tandem piston design in single 1-1/32" bore. Dual outlet 1/2"-20 and 9/16"-20 inverted flare outlets with 3/8"-24 NF thread pushrod.



PART#	DESCRIPTION	PRICE
260-4893	MASTER CYLINDER W/O PUSHROD	\$104.95
260-4894	MASTER CYLINDER W/ PUSHROD	\$119.44
260-2414	REBUILD KIT	\$26.25

3.2" face mount, proportioning valve recommended.

ADAPTER KIT

This kit adapts the tandem master cylinder to either Wilwood single composite pedal assembly.



PART #	DESCRIPTION	PRICE
250-3677	ADAPTER KIT	\$29.10

SLAVE CYLINDER "PULL STYLE"

Black anodized aircraft aluminum housing, non-corrosive piston, fully adjustable. Comes complete with fitting and bleeder valve, 7/8" dia. bore x 1-3/8" stroke.



PART #	DESCRIPTION	PRICE
260-1333	"PULL STYLE" SLAVE CYLINDER	\$57.75
260-5524	REBUILD KIT	\$13.05

COMBO MASTER CYLINDER

Precision machined high strength aluminum, these versatile master cylinders include both small and large size reservoirs that can be direct mounted or remote mounted if needed. Features 3/8"-24 female outlet thread and 5/16"-24 pushrod.

Face Mt. 2-1/4" c-c
Side Mt. 3" c-c



PART #	DESCRIPTION	PRICE
260-3372	5/8" DIA. COMBO MASTER CYLINDER (1.3" STROKE)	\$65.63
260-3374	3/4" DIA. COMBO MASTER CYLINDER (1.1" STROKE)	\$65.63
260-3376	7/8" DIA. COMBO MASTER CYLINDER (1.2" STROKE)	\$65.63
260-3378	1" DIA. COMBO MASTER CYLINDER (1" STROKE)	\$65.63
260-3380	1-1/8" DIA. COMBO MASTER CYLINDER (1" STROKE)	\$65.63
260-3880	REBUILD KIT FOR 5/8"	\$17.99
260-3881	REBUILD KIT FOR 3/4"	\$17.99
260-3882	REBUILD KIT FOR 7/8"	\$17.99
260-3883	REBUILD KIT FOR 1"	\$17.99
260-3884	REBUILD KIT FOR 1-1/8"	\$17.99

ALUMINUM MASTER CYLINDER

These Wilwood built master cylinders, from European descent, are compact in design and lightweight. Cast aluminum construction features option of with or without reservoir. Features 1.4" stroke, 3/8"-24 female outlet thread, and 5/16"-24 pushrod.



Without Reservoir



With Reservoir

Face Mt.
2-1/4"
c-c

REF	PART #	DESCRIPTION	PRICE
A	260-6087	5/8" DIA. MASTER CYLINDER	\$46.45
A	260-6089	3/4" DIA. MASTER CYLINDER	\$46.45
B	260-2636	5/8" DIA. MASTER CYLINDER	\$47.25
B	260-1304	3/4" DIA. MASTER CYLINDER	\$47.25
-	905	REBUILD KIT FOR 5/8"	\$24.00
-	909	REBUILD KIT FOR 3/4"	\$24.00
-	330-4355	REPLACEMENT CAP	\$7.22

RESIDUAL PRESSURE VALVES

Anodized aluminum valve holds pressure on your brake system, enough to maintain a firm pedal without brake drag.



REF	PART #	PRESSURE	APPLICATION	PRICE
A	260-1874	2 LBS. *	DISCS	\$17.28
A	260-1876	10 LBS.*	DRUMS	\$17.28
B	870-2	2 LBS. **	DISCS	\$22.24
B	870-4	4 LBS.**	DISCS	\$22.24
B	870-10	10 LBS. **	DRUMS	\$22.24

* 1/8" NPT Female - 1/8" NPT Female
** 1/8" NPT Female - 1/8" NPT Male

SINGLE PEDAL W/O MASTER CYLINDER

Anodized aluminum base and pedal with non-slip accepts Wilwood's revolutionary composite master cylinder. Lightweight high strength design weighs only 1.9 lbs.



Floor Mount



Swing Mount

PART #	DESCRIPTION	PRICE
340-1289	FLOOR MT (6:1 RATIO)	\$60.52
340-1290	SWING MT (7:1 RATIO)	\$60.52

REMOTE CABLE ADJUSTER

Adjusts front-to-rear brake bias during race conditions. Knob features bi-directional detent for positive adjustment. Cable is 5' long and can be cut for custom length. 3/8"-24 thread fits Wilwood and most commonly used bias bars.



PART #	DESCRIPTION	PRICE
340-4990	REMOTE CABLE ADJUSTER	\$43.68

BALANCE BAR ASSEMBLY

Available individually as shown, the 3/8"-24 threaded adjuster bar includes 5/16"-24 threaded aluminum clevises.



PART #	DESCRIPTION	PRICE
340-1757	BALANCE BAR ASSEMBLY	\$56.18

DUAL PEDAL W/OUT MASTER CYLINDER

These Dual Master Cylinder Pedal Assemblies feature extended travel balance bar assembly, with 3/8"-24 thread. Providing the adjustability of front-to-rear brake bias.



Floor Mount



Swing Mount



Reverse Swing Mount

PART #	DESCRIPTION	PRICE
340-1285	FLOOR MT (6:1 RATIO)	\$101.36
340-1287	SWING MT (7:1 RATIO)	\$101.36
340-5180	REVERSE SWING MT (5.1:1 RATIO)	\$144.15
340-5181	REVERSE SWING MT (6.25:1 RATIO)	\$144.15

PARK LOCK

Inline hydraulic lock. Push down brake pedal, depress park lock, and line pressure is held. To release push on brake pedal again.



PART #	DESCRIPTION	PRICE
875	PARK LOCK	\$36.00

LAUNCH CONTROL

Allows independent brake release front or rear, through the touch of a button. Includes solenoid valve, release button, and inline fuse.



PART #	DESCRIPTION	PRICE
861700	LAUNCH CONTROL	\$95.13

BRAKE LINE ACCESSORIES

REF	PART #	DESCRIPTION	DIMENSIONS	PRICE
A	884	BRAKE LINE ADAPTER- 90°	METRIC BUBBLE FEMALE TO 1/8" NPT MALE	\$5.68
B	894	BRAKE LINE ADAPTER- STRAIGHT	3/16" AMERICAN LINE FEMALE TO METRIC BUBBLE MALE	\$3.76
C	891	BRAKE LINE ADAPTER- STRAIGHT	3/16" AMERICAN LINE FEMALE TO 1/8" NPT MALE	\$3.28
D	892	BRAKE LINE ADAPTER- 90°	3/16" AMERICAN LINE FEMALE TO 1/8" NPT MALE	\$3.76
E	896	BRAKE LINE ADAPTER- STRAIGHT	METRIC BUBBLE FEMALE TO 1/8" NPT MALE	\$4.24
F	888	BRAKE LIGHT SWITCH	1/8" NPT MALE	\$6.96
G	889-F	TEE FOR BRAKE LIGHT SWITCH	1/8" NPT FEMALE ON SIDE TO 3/16" AMERICAN LINES	\$5.36
H	889-M	TEE FOR BRAKE LIGHT SWITCH	1/8" NPT FEMALE AND MALE ON SIDES TO 3/16" AMERICAN LINE	\$5.36
I	898	BRAKE LINE COUPLER- STRAIGHT	3/16" AMERICAN LINE FEMALE TO METRIC BUBBLE FEMALE	\$5.44
J	890	BRAKE LINE COUPLER- STRAIGHT	3/16" AMERICAN LINE FEMALE TO 3/16" AMERICAN LINE FEMALE	\$3.28
K	878-2	MANIFOLD	1/8" NPT FEMALE	\$12.32





cnc

Whether you're driving a "Fast Attack" desert vehicle or Top Fuel Dragster, CNC has a brake pedal and master cylinder combination designed to optimize your brake components. Precision manufactured from lightweight, high strength aluminum,

CNC components are designed to withstand the abuses of racing while providing complete reliability and performance. We stock a wide variety of pedals, master cylinders, and accessories.



CNC's premium quality master cylinders are an excellent choice for new construction or upgrading your existing pedal assemblies. Overall height of cylinders is 3", outfitted with 5/16"-24 pushrod and 1/8" NPT outlet.

ROUND MASTER CYLINDER

Face Mt. 2-1/4" c-c bolt space.



PART #	DESCRIPTION	PRICE
701-5/8	5/8" BORE	\$45.36
701-3/4	3/4" BORE	\$45.36
701-5/8-P	POLISHED 5/8" BORE	\$59.36
701-3/4-P	POLISHED 3/4" BORE	\$59.36

REPLACEMENT PARTS ROUND

PART #	DESCRIPTION	PRICE
903-R	5/8" REBUILD KIT	\$24.00
907-R	3/4" REBUILD KIT	\$24.00
1454	REPLACEMENT CAP	\$10.00
1452	REPLACEMENT GASKET	\$5.04
1450-R	BOOT	\$4.08

SQUARE MASTER CYLINDER

Side Mt. 3" c-c bolt space, (stainless steel sleeved) Face Mt. 2-1/4" c-c bolt space



PART #	DESCRIPTION	PRICE
702-5/8	5/8" BORE	\$54.60
702-3/4	3/4" BORE	\$54.60
702-7/8	7/8" BORE	\$54.60
702-1	1" BORE	\$54.60
702-1-1/16	1-1/16" BORE	\$54.60
702-3/4-P	POLISHED 3/4" BORE	\$68.60
702-7/8-P	POLISHED 7/8" BORE	\$68.60
702-1-P	POLISHED 1" BORE	\$68.60
702-1-1/16-P	POLISHED 1-1/16" BORE	\$68.80

REPLACEMENT PARTS SQUARE

PART #	DESCRIPTION	PRICE
903-S	5/8" REBUILD KIT	\$24.00
907-S	3/4" REBUILD KIT	\$24.00
911-S	7/8" REBUILD KIT	\$24.00
915-S	1" REBUILD KIT	\$24.00
918-S	1-1/16" REBUILD KIT	\$24.00
1453	REPLACEMENT LID	\$5.76
1451-F	REPLACEMENT GASKET	\$5.04
1450-S	REPLACEMENT BOOT	\$4.08

MASTER CYLINDER W/O RESERVOIR

Face Mt. 2-1/4" c-c bolt space.



Aluminum with stainless steel sleeve

PART #	DESCRIPTION	PRICE
712-5/8	5/8" BORE	\$54.60
712-3/4	3/4" BORE	\$54.60
712-7/8	7/8" BORE	\$54.60
712-1	1" BORE	\$54.60
712-1-1/16	1-1/16" BORE	\$54.60



All stainless steel

PART #	DESCRIPTION	PRICE
711-1-1/8	1-1/8" BORE	\$58.45
711-1-1/4	1-1/4" BORE	\$58.45

REPLACEMENT PARTS W/O RESERVOIR

PART #	DESCRIPTION	PRICE
903-N-R	5/8" REBUILD KIT	\$24.00
907-N-R	3/4" REBUILD KIT	\$24.00
911-N-R	7/8" REBUILD KIT	\$24.00
915-N-R	1" REBUILD KIT	\$24.00
918-N-R	1-1/16" REBUILD KIT	\$24.00
919-N-R	1-1/8" REBUILD KIT	\$24.00
920-N-R	1-1/4" REBUILD KIT	\$24.00

REMOTE RESERVOIR



PART #	DESCRIPTION	PRICE
1481	SM RESERVOIR (2" x 2" x 2-1/2")	\$54.40
1480	LG RESERVOIR (2" x 2" x 5")	\$54.40



DUAL MASTER CYLINDER

Side Mt. 3" c-c bolt space, stainless steel sleeved.



Includes easy fill cover as shown.

PART #	DESCRIPTION	PRICE
717-5/8-5/8	FIXED ROD, 5/8", 5/8" BORE	\$95.97
717-3/4-3/4	FIXED ROD, 3/4", 3/4" BORE	\$95.97
717-3/4-7/8	FIXED ROD, 3/4", 7/8" BORE	\$95.97
717-7/8-7/8	FIXED ROD, 7/8", 7/8" BORE	\$95.97

REPLACEMENT PARTS DUAL

PART #	DESCRIPTION	PRICE
903-D	5/8" REBUILD KIT	\$24.00
907-D	3/4" REBUILD KIT	\$24.00
911-D	7/8" REBUILD KIT	\$24.00

Sold for one bore only

MASTER CYLINDER HARDWARE

Anodized aluminum clevises are threaded 5/16"-24 with 1/4" dia. pin.



PART #	DESCRIPTION	PRICE
1457-B	BLUE CLEVIS	\$5.28
1457-R	RED CLEVIS	\$5.28
1455	3" PUSHROD	\$5.28
1456-A	3-1/2" PUSHROD	\$5.28
1456-B	4" PUSHROD	\$5.28
1456-C	4-1/2" PUSHROD	\$5.28
1456-D	5" PUSHROD	\$5.28

EASY FILL COVER

Complete with all rubber gaskets. Fits square type CNC master cylinders.



PART #	DESCRIPTION	PRICE
1458	EASY FILL COVER	\$13.44
1451-EZ	GASKET ONLY	\$5.04

BLEEDER LID

These replaceable lids feature air valves for pressure bleeding your brake system.



PART #	DESCRIPTION	PRICE
1459	SQ. CYLINDER KIT	\$17.68
1459A	RD. CYLINDER KIT	\$17.68

SINGLE CYLINDER PEDAL ASSEMBLIES

Available with choice of round or square reservoir master cylinders. On most models option of gray powder coated or chrome plated pedal.

FLOOR MOUNT

PART #	PEDAL	MASTER CYL.	PRICE
252 C 3/4	CHROME	3/4" ROUND	\$91.00
252 S 3/4	GRAY	3/4" ROUND	\$82.60
254 C 3/4	CHROME	3/4" SQUARE	\$106.40
254 S 3/4	GRAY	3/4" SQUARE	\$98.00
254 C 7/8	CHROME	7/8" SQUARE	\$106.40
254 S 7/8	GRAY	7/8" SQUARE	\$98.00
254 C 1	CHROME	1" SQUARE	\$106.40
254 S 1	GRAY	1" SQUARE	\$98.00

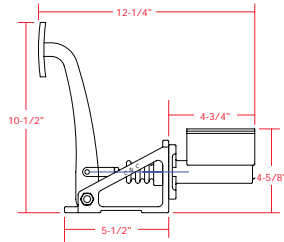

SWING MOUNT

PART #	PEDAL	MASTER CYL.	PRICE
264 C 3/4	CHROME	3/4" SQUARE	\$106.40
264 S 3/4	GRAY	3/4" SQUARE	\$98.00
264 C 7/8	CHROME	7/8" SQUARE	\$106.40
264 S 7/8	GRAY	7/8" SQUARE	\$98.00
264 C 1	CHROME	1" SQUARE	\$106.40
264 S 1	GRAY	1" SQUARE	\$98.00

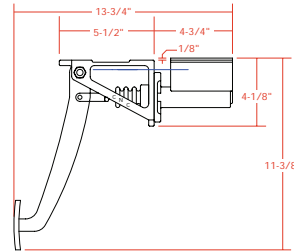

REVERSE SWING MOUNT

PART #	PEDAL	MASTER CYL.	PRICE
272 C 3/4	CHROME	3/4" ROUND	\$91.00
272 S 3/4	GRAY	3/4" ROUND	\$82.60
274 C 3/4	CHROME	3/4" SQUARE	\$106.40
274 S 3/4	GRAY	3/4" SQUARE	\$98.00
274 C 7/8	CHROME	7/8" SQUARE	\$106.40
274 S 7/8	GRAY	7/8" SQUARE	\$98.00
274 C 1	CHROME	1" SQUARE	\$106.40
274 S 1	GRAY	1" SQUARE	\$98.00

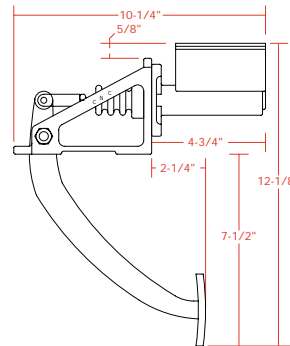

SUB - FLOOR MOUNT

PART #	PEDAL	MASTER CYL.	PRICE
284 C 3/4	CHROME	3/4" SQUARE	\$106.40
284 C 7/8	CHROME	7/8" SQUARE	\$106.40
284 C 1	CHROME	1" SQUARE	\$106.40

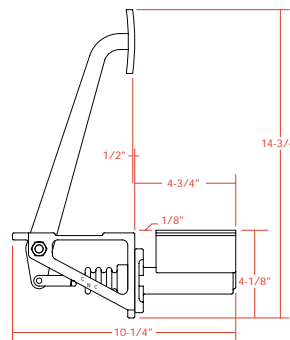

ADJUSTABLE PEDAL STOP

Limits pedal travel and prevents over-traveling pressure plate when using single pedal assembly for clutch application.

PART #	DESCRIPTION	PRICE
C32-110	ADJ PEDAL STOP	\$15.95



DUAL CYLINDER PEDAL ASSEMBLIES

Available with choice of round or square master cylinders. The 3/8"-24 thread balance bar provides front-to-rear brake bias adjustment.

FLOOR MOUNT

PART #	PEDAL	MASTER CYL.	PRICE
204 S 3/4 3/4	GRAY	3/4" RD, 3/4" RD	\$183.40
204 SD 3/4 3/4	GRAY	3/4" SQ, 3/4" SQ	\$208.60
204 SD 3/4 7/8	GRAY	3/4" SQ, 7/8" SQ	\$208.60
204 S 5/8 3/4	GRAY	5/8" RD, 3/4" RD	\$183.40
204 SD 7/8 7/8	GRAY	7/8" SQ, 7/8" SQ	\$208.60

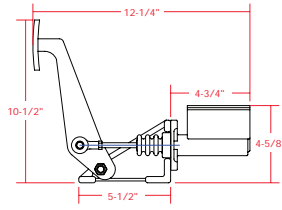

SWING MOUNT

PART #	PEDAL	MASTER CYL.	PRICE
214 SD 3/4 3/4	GRAY	3/4" SQ, 3/4" SQ	\$208.60
214 SD 3/4 7/8	GRAY	3/4" SQ, 7/8" SQ	\$208.60
214 SD 5/8 3/4	GRAY	5/8" SQ, 3/4" SQ	\$208.60
214 SD 7/8 7/8	GRAY	7/8" SQ, 7/8" SQ	\$208.60

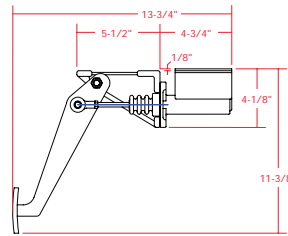

REVERSE SWING MOUNT

PART #	PEDAL	MASTER CYL.	PRICE
224 SD 3/4 3/4	GRAY	3/4" SQ, 3/4" SQ	\$217.00
224 SD 3/4 7/8	GRAY	3/4" SQ, 7/8" SQ	\$217.00
224 SD 5/8 3/4	GRAY	5/8" SQ, 3/4" SQ	\$217.00
224 SD 7/8 7/8	GRAY	7/8" SQ, 7/8" SQ	\$217.00

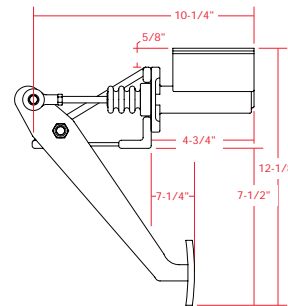

SUB - FLOOR MOUNT

Ideal for installations with firewall restrictions.

PART #	PEDAL	MASTER CYL.	PRICE
245 C 3/4 3/4	CHROME	3/4" SQ, 3/4" SQ	\$303.80
245 C 3/4 7/8	CHROME	3/4" SQ, 7/8" SQ	\$303.80
245 C 5/8 3/4	CHROME	5/8" SQ, 3/4" SQ	\$303.80
245 C 7/8 7/8	CHROME	7/8" SQ, 7/8" SQ	\$303.80

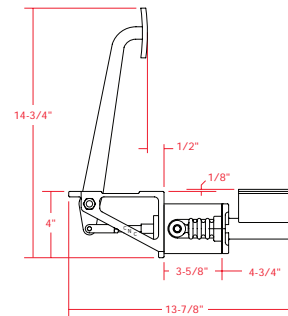

BALANCE BAR ADJUSTER

Adjust brake bias from driver's seat with the CNC balance bar adjuster. The 3/8"-24 threaded coupler fits CNC bias bars and most other brands.

PART #	DESCRIPTION	PRICE
830-3	3 FT CABLE	\$47.20
830-5	5 FT CABLE	\$47.20



BALANCE BAR

Available separately as shown, has 3/8"-24 threaded adjuster with 5/16"-24 rod ends.

PART #	DESCRIPTION	PRICE
1215	BALANCE BAR	\$60.48



HYDRAULIC PEDAL WITHOUT THROTTLE

Designed for high strength and severe duty. Includes total seal rubber boots, fittings for 3/16" standard american brake line, and slave cylinder. Choice of round or square master cylinders.



PART #	PEDAL	MASTER CYL.	PRICE
122 BB 3/4 3/4	BLACK	3/4" RD, 3/4" RD	\$182.00
122 CB 3/4 3/4	CHROME	3/4" RD, 3/4" RD	\$198.00
122 CBP 3/4 3/4	* CHROME	3/4" RD, 3/4" RD	\$246.00
124 BB 3/4 3/4	BLACK	3/4" SQ, 3/4" SQ	\$214.00
124 CB 3/4 3/4	CHROME	3/4" SQ, 3/4" SQ	\$227.00
124 CBP 3/4 3/4	* CHROME	3/4" SQ, 3/4" SQ	\$275.00
124 BB 3/4 7/8	BLACK	3/4" SQ, 7/8" SQ	\$214.00
124 CB 3/4 7/8	CHROME	3/4" SQ, 7/8" SQ	\$227.00
124 CBP 3/4 7/8	* CHROME	3/4" SQ, 7/8" SQ	\$275.00
124 BB 3/4 1	BLACK	3/4" SQ, 1" SQ	\$214.00
124 CB 3/4 1	CHROME	3/4" SQ, 1" SQ	\$227.00
124 CBP 3/4 1	* CHROME	3/4" SQ, 1" SQ	\$275.00

* Polished Assembly and Master Cylinders

HYDRAULIC PEDAL WITH THROTTLE

Same design and features as 122/124 Series assembly, with built-in gas pedal for cable style hook up.



PART #	PEDAL	MASTER CYL.	PRICE
112 BB 3/4 3/4	BLACK	3/4" RD, 3/4" RD	\$201.00
112 CB 3/4 3/4	CHROME	3/4" RD, 3/4" RD	\$224.00
112 CBP 3/4 3/4	* CHROME	3/4" RD, 3/4" RD	\$272.00
114 BB 3/4 3/4	BLACK	3/4" SQ, 3/4" SQ	\$234.00
114 CB 3/4 3/4	CHROME	3/4" SQ, 3/4" SQ	\$251.00
114 CBP 3/4 3/4	* CHROME	3/4" SQ, 3/4" SQ	\$299.00
114 BB 3/4 7/8	BLACK	3/4" SQ, 7/8" SQ	\$234.00
114 CB 3/4 7/8	CHROME	3/4" SQ, 7/8" SQ	\$251.00
114 CBP 3/4 7/8	* CHROME	3/4" SQ, 7/8" SQ	\$299.00
114 BB 3/4 1	BLACK	3/4" SQ, 1" SQ	\$234.00
114 CB 3/4 1	CHROME	3/4" SQ, 1" SQ	\$251.00
114 CBP 3/4 1	* CHROME	3/4" SQ, 1" SQ	\$299.00

* Polished Assembly and Master Cylinders

ADJUSTABLE PEDAL MOUNTING PLATE

This mounting plate has three different locations for the pedal assembly, with an overall adjustment of 4". It can be used with all dual cylinder pedal assemblies, includes quick change cable mount for morse cables.

PART #	DESCRIPTION	PRICE
1222-CT	ADJUSTABLE PEDAL MOUNTING PLATE	\$44.96



BRAIDED LINE KIT

For use with adjustable pedal mounting plate and clutch/brake assembly listed above. Includes necessary fittings and brake line manifold for union of 18" braided lines to hard line.



PART #	DESCRIPTION	PRICE
864-2	2 LINE KIT (CLUTCH & BRAKE)	\$58.73
864-3	3 LINE KIT (CLUTCH, BRAKE, & THROTTLE)	\$73.43

SLAVE CYLINDER

Equipped with 3/16" american brake fittings and bleeder screw. 7/8" bore dia.



REF	PART #	DESCRIPTION	STROKE	PRICE
A	300-B	PULL STYLE- BLUE	1"	\$43.40
A	300-P	PULL STYLE- POLISHED	1"	\$58.80
A	933	PULL STYLE REBUILD KIT	-	\$24.00
B	305-B	PUSH STYLE- BLUE	1-1/4"	\$47.60
B	1312	PUSHROD	-	\$12.24
B	942	PUSH STYLE REBUILD KIT	-	9.60

BILLET ALUMINUM CALIPER

Super compact dual action design. Machined from 7075-T6 billet aluminum. Features internal crossover passages. 3/16" dia. cross bolt retain pads, accepts DLS pads listed on page 37.



PART #	DESCRIPTION	PRICE
623-R	RIGHT SIDE	\$103.46
623-L	LEFT SIDE	\$103.46

Right side shown, 3.250" bolt pattern, 1/8" NPT inlet port.

IN-LINE STAGING BRAKE

Allows both foot and hand brake control. May be plumbed in-line to control front or rear brakes.



PART #	DESCRIPTION	PRICE
412 SB 3/4	3/4" BORE SIZE	\$99.40
925	3/4" REBUILD KIT	\$30.40
1402 B	REPLACEMENT BLUE KNOB	\$7.04
1402 R	REPLACEMENT RED KNOB	\$7.04

HAND BRAKE

Ideal for hand control of brake system in applications that do not require or allow for foot brake assembly.



PART #	MASTER CYLINDER	PRICE
402 A 3/4	3/4" ROUND	\$113.40
402 AS 3/4	3/4" SQUARE	\$121.80
402 AS 7/8	7/8" SQUARE	\$121.80

ALUMINUM GAS PEDAL

Aluminum cast with non-skid foot surface. Features adjustable stop and built in return spring. Works great with Morse cables.



#174 features three location mounting points.



PART #	DESCRIPTION	PRICE
170	SIDE MOUNT	\$28.00
171	BACK MOUNT	\$28.00
174	W/ FOOTREST	\$32.20
170-P	POLISHED SIDE MOUNT	\$42.00
171-P	POLISHED BACK MOUNT	\$42.00
174-P	POLISHED W/ FOOTREST	\$46.20

HYDRAULIC THROTTLE

Flexible line simplifies difficult throttle installations. Factory assembled with 10' of line, available with or without pedal. *Not recommended for blown applications or race cars.*

REF	PART #	DESCRIPTION	PRICE
A	290-10	HYDRAULIC THROTTLE W/ BRKT FOR 122 SERIES PEDALS	\$133.00
B	290-P-10	HYDRAULIC THROTTLE W/ PEDAL	\$170.80
-	1289	TUBE COUPLER	\$4.80
-	1290-12	5/16" DIA TUBE (12FT)	\$19.20
-	1291-S	STRAIGHT FTG *	\$3.44
-	1291-E	90 DEGREE FTG *	\$3.44
-	1292	COMPRESSION SLEEVE	\$1.28
-	1293	LINE NUT	\$1.60
-	1294	BOOT	\$7.60

* 1/8" NPT Male to 5/16" Nylon Tubing

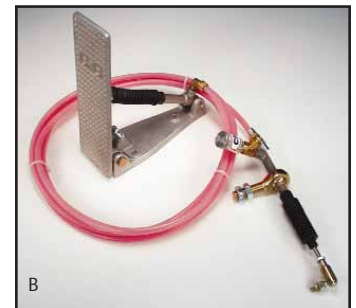

Replacement Parts

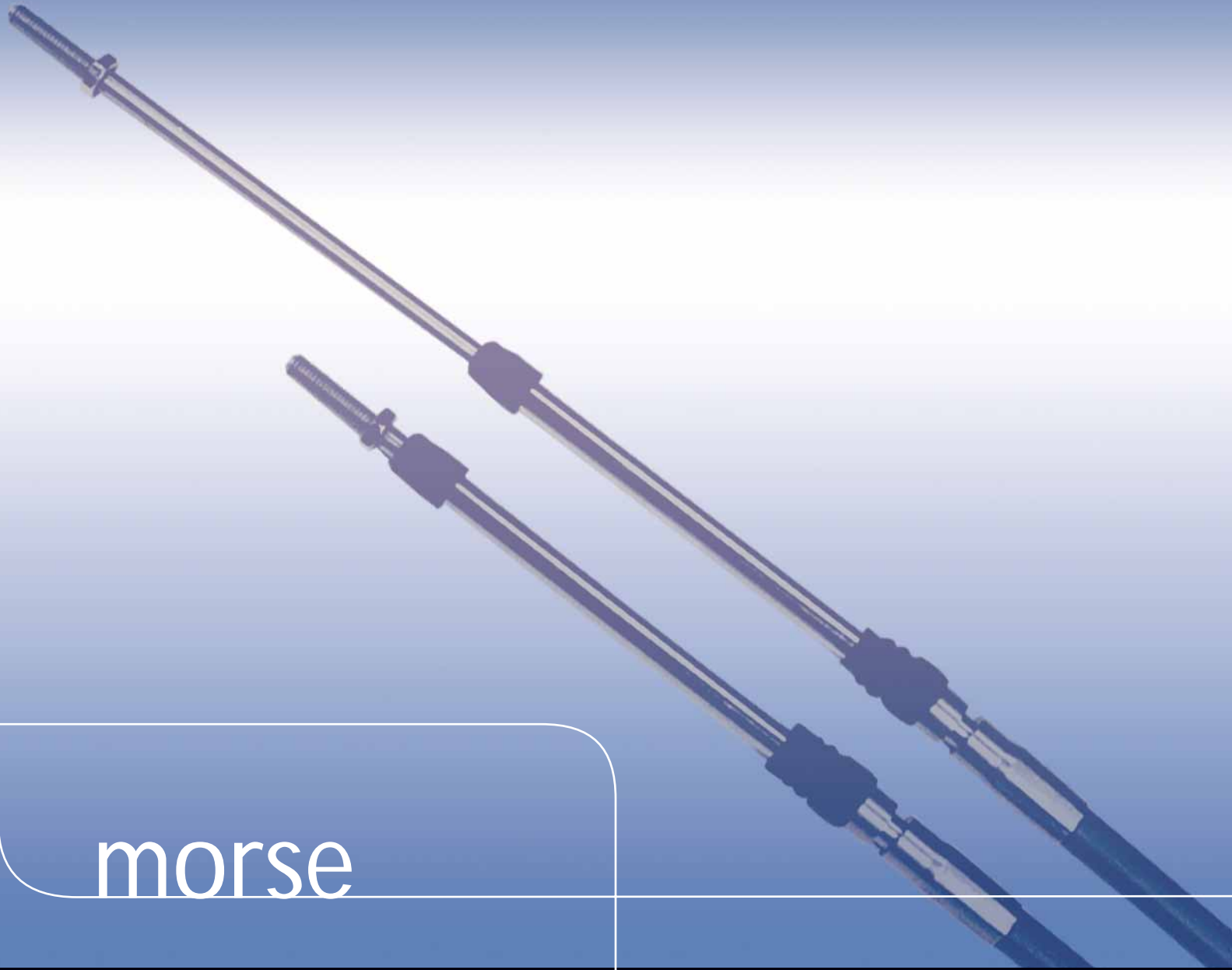

morse

Morse Controls offer the high quality and reliability required for both on and off road racing and extreme use environments. Their cable-actuated remote controls provide positive, smooth operation- a result of sealed and internally lubricated construction. Their flexible

“Red Jacket” cables provide positive load transfer with minimum backlash. Morse offers a wide selection of cables and mounting components for every application and are perfect for throttle linkages, shifter hookups, fuel shut-offs, and parachute releases.



Positive, smooth operating Morse cables are sealed and internally lubricated. These cables are perfect for any cable operated application such as throttle linkages, shifter hookups, fuel shut-offs, and parachute releases.

To determine the proper length for your application, measure the cable length between the attaching points. Be sure to use a flexible rule to snake through the cable route.

PUSH/PULL "RED JACKET" CABLES

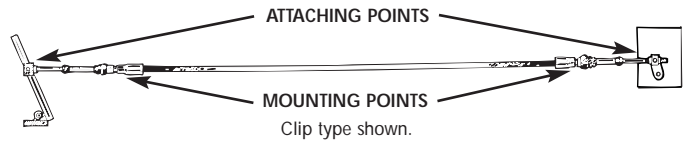

CLIP TYPE CABLE

STANDARD & SUPREME

Clip mounted, these cables provide 3" of travel and require the choice of mounting hardware listed below. Available in either standard type (solid wire core) or supreme type (multi-strand core). The supreme cable is more flexible and capable of tighter radius bends with less resistance. Both styles feature 10-32 NF threaded rods and the "Red Jacket" housing measures .343" dia.



LENGTH	STANDARD		SUPREME	
	CABLE	PRICE	CABLE	PRICE
2 FT	-		820-2	\$32.44
3 FT	810-3	\$26.27	820-3	\$33.92
4 FT	810-4	\$26.80	820-4	\$35.31
5 FT	810-5	\$27.52	820-5	\$36.65
6 FT	810-6	\$28.09	820-6	\$37.88
7 FT	810-7	\$28.76	820-7	\$39.27
8 FT	810-8	\$29.43	820-8	\$40.70
9 FT	810-9	\$30.05	820-9	\$41.85
10 FT	810-10	\$30.62	820-10	\$43.28
11 FT	810-11	\$31.29	820-11	\$44.67
12 FT	810-12	\$31.77	820-12	\$46.00
13 FT	810-13	\$32.39	820-13	\$47.32
14 FT	810-14	\$33.01	820-14	\$48.33
15 FT	810-15	\$33.68	820-15	\$49.33
16 FT	810-16	\$34.11	820-16	\$50.37
17 FT	810-17	\$35.05	820-17	\$51.34
18 FT	810-18	\$35.78	820-18	\$52.37
19 FT	810-19	\$36.46	820-19	\$53.40
20 FT	810-20	\$37.17	820-20	\$54.37



CLIP TYPE HOLD DOWNS

SINGLE QUICK DISCONNECT



PART #	DESCRIPTION	PRICE
846	SINGLE QUICK DISCONNECT	\$8.17

DUAL QUICK DISCONNECT



PART #	DESCRIPTION	PRICE
846-D	DUAL QUICK DISCONNECT	\$21.51

SADDLE MOUNT WITH SHIM



PART #	DESCRIPTION	PRICE
847	SADDLE MT W/ SHIM	\$6.64

HALF CLAMP



PART #	DESCRIPTION	PRICE
C73-375	HALF CLAMP	\$7.80

FULL CLAMP



PART #	DESCRIPTION	PRICE
C73-376	FULL CLAMP	\$8.40

TECH TIP

For the best efficiency and longest operating life, it is recommended to install the cable so the heaviest load is in a "pull" application.

THREADED BULKHEAD CABLE

Features 7/16"-20 threaded mounting bulkhead on each end; these cables provide 2" of travel. This is a multi-strand supreme cable, capable of tight radius bends with minimal resistance. Each end has 10-32 NF threaded rods, the "Red Jacket" housing measures .343" dia.



LENGTH	PART #	PRICE
3 FT	820-3-B	\$52.14
4 FT	820-4-B	\$53.48
5 FT	820-5-B	\$54.76
6 FT	820-6-B	\$56.07
7 FT	820-7-B	\$57.41
8 FT	820-8-B	\$58.70
9 FT	820-9-B	\$60.03
10 FT	820-10-B	\$61.36
11 FT	820-11-B	\$62.68
12 FT	820-12-B	\$63.96

CABLE ACCESSORIES

May be used for clip type or bulkhead cables.

THREAD CABLE EXTENSION

Perfect for in-between lengths, 10-32 NF threaded rod may be cut if needed.



LENGTH	PART #	PRICE
4"	849-4	\$5.04
8"	849-8	\$6.64
12"	849-12	\$7.60

PIVOT END (THREADED)

10-32 threaded, 1/4" dia. pin with .190" grip.



PART #	DESCRIPTION	PRICE
C73-382	PIVOT END (THREADED)	\$9.75

PIVOT END (THRU HOLE)

3/32 dia. hole, 1/4" dia. pin with .250" grip.



PART #	DESCRIPTION	PRICE
C73-395	PIVOT END (THRU HOLE)	\$12.75

KNOBS



PART #	DESCRIPTION	PRICE
C73-384	ROUND BLACK KNOB (10-32 FEMALE X 1-3/8" DIA.)	\$7.15
C73-386	T-KNOB BLACK (10-32 FEMALE X 2-3/8" WIDE)	\$7.15
C73-390	T- KNOB RED (1/4-20 FEMALE X 2-3/8" WIDE)	\$7.15

BALL JOINT END

Quick release, 10-32 female x 10-32 stud.



PART #	DESCRIPTION	PRICE
842	BALL JOINT END	\$6.07

CLEVIS END

10-32 female 3/16" slot and 3/16" dia. pin



PART #	DESCRIPTION	PRICE
845	CLEVIS END	\$6.07

ROD END

10-32 female x 3/16" hole.



PART #	DESCRIPTION	PRICE
CW3	ROD END	\$4.70

SOLID ROD END

10-32 female x 5/16" dia. hole.



PART #	DESCRIPTION	PRICE
C73-380	SOLID ROD END	\$5.80

CABLE BOOTS

Fits both clip or bulkhead cables.

PART #	DESCRIPTION	PRICE
C73-370	CABLE BOOTS (4 PCS)	\$5.95



DRAG CHUTE CABLE KIT

Packaged in a convenient kit to simplify installation of cable release system for a parachute. Includes standard 15-ft. solid wire core, clip type cable with exposed .075" wire on one end (may be cut to desired length), CNC machined aluminum lever, clevis end, cable mounting hardware, and weld on tabs.



PART #	DESCRIPTION	PRICE
C42-509	CHUTE CABLE KIT	\$59.95
C42-510	LEVER ONLY	\$9.95
815-15	15-FT. CABLE ONLY	\$34.25

TEE HANDLE CABLE PACKAGE

Bulkhead mount on one end (3/8"-24 NF) with black tee knob and exposed .075" solid wire on the other end. Used for universal hook up. The 20-ft. long cable can be cut to desired length. The "Red Jacket" housing measures .270" dia., choose one of the optional screw on housing ends for either clip type or bulkhead mounting.



PART #	DESCRIPTION	PRICE
805-20-B	20-FT. CABLE PKG	\$54.69

TEE HANDLE CABLE ACCESSORIES

REF	PART #	DESCRIPTION	PRICE
A	C73-393	SCREW ON END CLIP TYPE	\$21.06
B	C73-394	SCREW ON END BULKHEAD	\$26.70
-	C73-390	RED T-KNOB 1/4"-20 NC THREAD PIVOT END (THRU HOLE)	\$7.15
C	C73-395	3/32" DIA. HOLE 1/4" DIA. PIN W/ .250" GRIP	\$12.75



Shown with optional screw on ends.



auto meter

Auto Meter has been the leader in high performance gauges for over 44 years. Well known for their highly reliable and accurate gauges, Auto Meter products are proven for racing and

street performance and offer a complete array of styles and applications for every high performance vehicle. We stock a wide selection of high-tech meters to fit every racing cockpit.



TRADITIONAL SERIES

CHROME BEZEL DESIGN

2" MECHANICAL & ELECTRICAL GAUGES

The traditional chrome design is ideal for race applications with size constraints or custom car builders. Available in both mechanical or electrical movements, the mechanical gauges offer a full 270° sweep dial and electrical gauges include the necessary senders. Gauges can be panel mounted or installed in optional chrome mounting cups.



2411

2412

MECHANICAL GAUGES

PART #	DESCRIPTION	PRICE
2401	BOOST/ VACUUM (30" HG/20 PSI)	\$38.59
2411	FUEL PRESSURE (0-15 PSI)	\$33.37
2412	FUEL PRESSURE (0-100 PSI)	\$34.88
2413	FUEL PRESSURE WITH ISOLATOR (0-15#)	\$100.13
2421	OIL PRESSURE (0-100 PSI)	\$31.46
2422	OIL PRESSURE (0-200 PSI)	\$33.95
2431	WATER TEMPERATURE (140°-280° F) 6' CAP TUBE	\$48.39
2432	WATER TEMPERATURE (120°-240° F) 6' CAP TUBE	\$50.13
2433	WATER TEMPERATURE (120°-240° F) 12' CAP TUBE	\$54.51
2441	OIL TEMPERATURE (140°-280° F) 6' CAP TUBE	\$50.13
2484	VACUUM (30" HG)	\$34.02



2422



2441

ELECTRICAL GAUGES

PART #	DESCRIPTION	PRICE
2514	FUEL LEVEL (0 OHMS EMPTY/ 90 OHMS FULL)*	\$28.42
2515	FUEL LEVEL (73 OHMS EMPTY/ 8-12 OHMS FULL)*	\$28.42
2516	FUEL LEVEL (240 OHMS EMPTY/ 33 OHMS FULL)**	\$28.42
2522	OIL PRESSURE (0-100 PSI)	\$43.42
2532	WATER TEMPERATURE (100°-250° F)	\$33.96
2536	CYLINDER HEAD TEMPERATURE (140°-340° F)	\$33.40
2542	OIL TEMPERATURE (100°-250° F)	\$34.08
2543	OIL TEMPERATURE (140°-300° F)	\$34.08
2552	TRANSMISSION TEMPERATURE (100°-250° F)	\$34.08
2586	AMMETER (60-0-60 AMPS)***	\$28.19
2585	CLOCK QUARTZ MOVEMENT (12 VOLTS)	\$47.52
2587	HOURMETER (8-32 VOLTS DC INPUT)	\$36.67
2592	VOLTMETER (8-18 VOLTS)	\$27.74

*Uses vehicle's stock sender. #2514 fits most GM. #2515 fits most Ford & Chrysler

**Uses Part # 3262 fuel level sender (not included)

***CAUTION: Use only on alternators with output of 60 amps or less. Higher output alternators must use voltmeter. Must be installed by experienced mechanic.

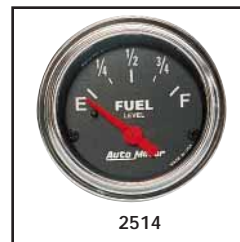

2514



2587

BOOST MEMORY KIT



This compact kit accurately records maximum reading on all boost and blower gauges, this allows you to concentrate on driving and not watching the gauge. Easily reset and is not influenced by vibration or fuel vapor. All fittings are 1/8" NPT.

PART #	DESCRIPTION	PRICE
C76-165	BOOST MEMORY KIT	\$43.95
C76-166	RELIEF VALVE (ONLY)	\$19.00
C76-167	CHECK VALVE (ONLY)	\$20.60



SPORT COMP SERIES

2-1/16" & 2-5/8" MECHANICAL & ELECTRICAL GAUGES

The trademarked competition appearance and rugged, reliable performance have made these gauges the standard in racing today. The bold, easy to read dial faces include florescent red pointers for quick-glance monitoring. The electrical gauges now include a rugged air core meter movement for maximum accuracy and quick response time.



MECHANICAL GAUGES

2-1/16"	PRICE	2-5/8"	PRICE	DESCRIPTION
3301	\$42.09	3401	\$44.92	BOOST/ VACUUM (30" HG/20 PSI)
-	-	3402	\$44.92	BLOWER PRESSURE (0-60 PSI)
-	-	3404	\$44.92	BOOST (0-35 PSI)
-	-	3405	\$46.33	BLOWER PRESSURE (0-100 PSI)
3311	\$36.97	3411	\$37.44	FUEL PRESSURE (0-15 PSI)
3312	\$38.39	3412	\$39.35	FUEL PRESSURE (0-100 PSI)
3313	\$106.54	3413	\$106.16	FUEL PRESSURE W/ ISOLATOR (0-15 PSI)
3321	\$36.08	3421	\$37.68	OIL PRESSURE (0-100 PSI)
3322	\$37.39	3422	\$39.68	OIL PRESSURE (0-200 PSI)
3331	\$53.23	3431	\$55.50	WATER TEMPERATURE (140°-280° F.) 6' CAP TUBE
3332	\$55.05	3432	\$57.19	WATER TEMPERATURE (120°-240° F.) 6' CAP TUBE
3333	\$59.42	3433	\$61.32	WATER TEMPERATURE (120°-240° F.) 12' CAP TUBE
-	-	3435	\$59.19	TEMPERATURE (140°-340° F.) 6' CAP TUBE
3341	\$55.05	3441	\$57.88	OIL TEMPERATURE (140°-280° F.) 6' CAP TUBE
-	-	3443	\$61.32	OIL TEMPERATURE (140°-280° F.) 12' CAP TUBE
3351	\$56.37	3451	\$58.32	TRANSMISSION TEMPERATURE (140°-280° F.) 8' CAP TUBE
3384	\$36.78	3484	\$38.48	VACUUM (30" HG)



ELECTRICAL GAUGES

2-1/16"	PRICE	2-5/8"	PRICE	DESCRIPTION
3314	\$31.54	3514	\$36.87	FUEL LEVEL (0 OHMS EMPTY/ 90 OHMS FULL)*
3315	\$31.54	3515	\$36.87	FUEL LEVEL (73 OHMS EMPTY/ 8-12 OHMS FULL)*
3316	\$31.54	3516	\$36.87	FUEL LEVEL (240 OHMS EMPTY/ 33 OHMS FULL)**
-	-	3262	\$28.68	FUEL LEVEL SENDER (240 OHMS EMPTY/ 33 OHMS FULL)
3327	\$49.81	3522	\$51.34	OIL PRESSURE (0-100 PSI)
3337	\$37.61	3531	\$42.80	WATER TEMPERATURE (100°-250° F.)
3336	\$37.61	3536	\$44.66	CYLINDER HEAD TEMPERATURE (140°-340° F.)
3347	\$37.61	3542	\$44.66	OIL TEMPERATURE (100°-250° F.)
3348	\$37.61	3543	\$44.66	OIL TEMPERATURE (140°-300° F.)
3357	\$37.61	3552	\$44.66	TRANSMISSION TEMPERATURE (100°-250° F.)
-	-	3586	\$44.23	AMMETER (60-0-60 AMPS)***
3391	\$32.00	3592	\$37.94	VOLTMETER (8-18 VOLTS)



*Uses vehicle's stock sender. #3514 fits most GM. #3515 fits most Ford & Chrysler

**Uses Part # 3262 fuel level sender (not included)

***Caution: Use only on alternators with output of 60 amps or less.

Higher output alternators must use voltmeter. Must be installed by experienced mechanic.

PRO COMP SERIES

2-5/8" MECHANICAL & ELECTRICAL GAUGES

Pro Comp liquid-filled mechanical gauges are designed for racing applications with extreme vibrations or violent pounding. The bourdon tube gauge mechanism is encased in a special dampening fluid that not only provides steadiness to the pointer but also adds longer life to the instrument. Pro Comp electric gauges include a rugged air core meter movement and are the ideal choice for applications where routing electric wires are required.



LIQUID FILLED MECHANICAL GAUGES

PART #	DESCRIPTION	PRICE
5401	BOOST/ VACUUM (30" HG/ 20 PSI)	\$53.57
5402	BLOWER PRESSURE (0-60 PSI)	\$53.57
5404	BOOST (0-35 PSI)	\$53.57
5405	BLOWER PRESSURE (0-100 PSI)	\$53.57
5411	FUEL PRESSURE (0-15 PSI)	\$49.67
5412	FUEL PRESSURE (0-100 PSI)	\$50.39
5413	FUEL PRESSURE W/ ISOLATOR (0-15 PSI)	\$122.08
5421	OIL PRESSURE (0-100 PSI)	\$49.86
5422	OIL PRESSURE (0-200 PSI)	\$51.11
5423	PRESSURE (0-300 PSI)	\$52.49
5426	BRAKE PRESSURE (0-2000 PSI)	\$74.45
5431	WATER TEMPERATURE (140°-280° F.) 6' CAP TUBE	\$76.69
5432	WATER TEMPERATURE (120°-240° F.) 6' CAP TUBE	\$77.88
5433	WATER TEMPERATURE (120°-240° F.) 12' CAP TUBE	\$81.88
5434	WATER TEMPERATURE (140°-280° F.) 4' CAP TUBE	\$73.83
5435	TEMPERATURE (140°-340° F.) 8' CAP TUBE	\$79.19
5441	OIL TEMPERATURE (140°-280° F.) 6' CAP TUBE	\$77.88
5443	OIL TEMPERATURE (140°-280° F.) 12' CAP TUBE	\$81.82
5451	TRANSMISSION TEMPERATURE (140°-280° F.) 8' CAP TUBE	\$79.02
5484	VACUUM (30" HG)	\$49.60



ELECTRICAL GAUGES

PART #	DESCRIPTION	PRICE
5415	FUEL LEVEL (0 OHMS EMPTY/ 90 OHMS FULL)*	\$35.28
5416	FUEL LEVEL (73 OHMS EMPTY/ 8-12 OHMS FULL)*	\$35.28
5417	FUEL LEVEL (240 OHMS EMPTY/ 33 OHMS FULL)**	\$35.28
3262	FUEL LEVEL SENDER (240 OHMS EMPTY/ 33 OHMS FULL)	\$28.68
5427	OIL PRESSURE (0-100 PSI)	\$52.00
5437	WATER TEMPERATURE (100°-250° F.)	\$43.03
5447	OIL TEMPERATURE (140°-300° F.)	\$45.04
5457	TRANSMISSION TEMPERATURE (100°-250° F.)	\$45.04
5486	AMMETER(60-0-60 AMPS)***	\$46.79
5492	VOLTMETER (8-18 VOLTS)	\$38.60

*Uses vehicle's stock sender. #5415 fits most GM. #5416 fits most Ford & Chrysler

**Uses Part # 3262 fuel level sender (not included)

***Caution: Use only on alternators with output of 60 amps or less.

Higher output alternators must use voltmeter. Must be installed by experienced mechanic.



ULTRA-LITE SERIES

2-1/16" & 2-5/8" ULTRA-LITE GAUGES

All aluminum construction greatly reduces the weight of these premium race gauges, making them the hottest new instruments in the racing industry. A clear anodized aluminum face dramatically displays the "easy-to-read" red pointer. Senders included with electrical gauges.

MECHANICAL GAUGES

2-1/16"	PRICE	2-5/8"	PRICE	DESCRIPTION
4301	\$45.48	4401	\$51.12	BOOST (30" HG/ 20 PSI)
-	-	4402	\$60.15	BLOWER PRESSURE (0-60 PSI)
4311	\$39.02	4411	\$42.24	FUEL PRESSURE (0-15 PSI)
4312	\$40.34	4412	\$42.67	FUEL PRESSURE (0-100 PSI)
4313	\$108.15	4413	\$118.53	FUEL PRESSURE W/ ISOLATOR (0-15 PSI)
4321	\$39.47	4421	\$43.50	OIL PRESSURE (0-100 PSI)
4322	\$40.08	4422	\$44.10	OIL PRESSURE (0-200 PSI)
-	-	4426	\$70.24	BRAKE PRESSURE (0-2000 PSI)
4331	\$55.41	4431	\$66.82	WATER TEMPERATURE (140°-280° F.) 6' CAP TUBE
4332	\$56.48	4432	\$68.32	WATER TEMPERATURE (120°-240° F.) 6' CAP TUBE
-	-	4434	\$66.56	WATER TEMPERATURE (140°-280° F.) 3' CAP TUBE
-	-	4435	\$70.89	TEMPERATURE (140°-340° F.) 8' CAP TUBE
-	-	4436	\$65.20	TEMPERATURE (140°-340° F.) 4' CAP TUBE
4341	\$56.48	4441	\$68.32	OIL TEMPERATURE (140°-280° F.) 6' CAP TUBE
4351	\$57.80	4451	\$70.89	TRANS TEMPERATURE (140°-280° F.) 8' CAP TUBE
-	-	4484	\$44.80	VACUUM (30" HG)

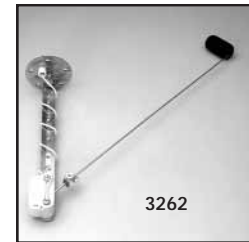
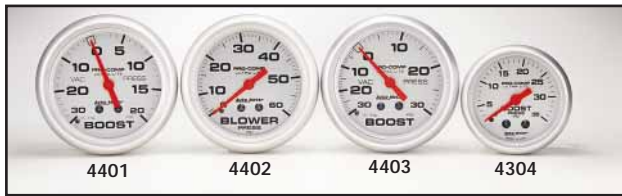

ELECTRICAL GAUGES

2-1/16"	PRICE	2-5/8"	PRICE	DESCRIPTION
4314	\$34.24	4414	\$41.13	FUEL LEVEL (0 OHMS EMPTY/ 90 OHMS FULL)*
4315	\$34.24	4415	\$41.13	FUEL LEVEL (73 OHMS EMPTY/ 8-12 OHMS FULL)*
4316	\$34.24	4416	\$41.13	FUEL LEVEL (240 OHMS EMPTY/ 33 OHMS FULL)**
-	-	3262	\$28.68	FUEL LEVEL SENDER (240 OHMS EMPTY/ 33 OHMS FULL)
4327	\$52.50	4427	\$60.44	OIL PRESSURE (0-100 PSI)
4337	\$39.79	4437	\$47.73	WATER TEMPERATURE (100°-250° F.)
4348	\$40.32	4447	\$47.73	OIL TEMPERATURE (140°-300° F.)
4357	\$40.32	4457	\$47.73	TRANS TEMPERATURE (100°-250° F.)
4391	\$34.70	4491	\$40.31	ELECTRIC VOLTMETER (8-18 VOLTS)



*Uses vehicle's stock sender. #4414 fits most GM. #4415 fits most Ford & Chrysler

**Uses Part # 3262 fuel level sender (not included)

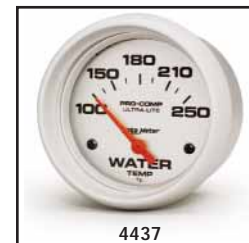

SPORT COMP SERIES

5" & 3-3/8" IN-DASH TACHOMETERS & SPEEDOMETERS

Bold, easy to read dial faces and reliable performance match up for a serious competition look. Two sizes are available to match most dashboard size requirements. The tachometer includes a rugged air core meter movement for accurate, fast action response. The speedometer includes a trip odometer to help measure mileage.



PART #	DESCRIPTION	PRICE
3990	5" 10,000 RPM IN-DASH ELEC TACH (STD/ELEC)	\$124.56
3991	3-3/8" 8,000 RPM IN-DASH ELEC TACH (STD/ELEC)	\$88.64
3992	3-3/8" 120 MPH IN-DASH MECH SPEEDOMETER	\$73.58
3994	5" 120 MPH IN-DASH MECH SPEEDOMETER	\$109.84



MAGNETO SIGNAL CONVERTER

The converter box allows any Auto Meter tachometer, Pro-Shift lite, or RPM activated module to be used in most magneto applications.



PART #	DESCRIPTION	PRICE
9118	SIGNAL CONVERTER	\$48.54

BRAIDED STAINLESS STEEL HOSE

For use with all mechanical pressure gauges, recommended for use with fuel pressure gauges. Includes #4 line and adapter fittings.



PART #	DESCRIPTION	PRICE
3227	3 FT LONG	\$29.95
3228	6 FT LONG	\$48.66

SPORT-COMP SERIES**5" SHIFT-LITE TACHOMETERS**

When critical shifting is a priority, the Sport Comp Shift-Lite tachometers are the answer. These tachs feature an advanced air core meter movement, which provides accuracy and quicker response. They also include the exclusive rubber-lined shock-strap for vibration-free readings. A bright amber shift-lite signals any pre-selected rpm to notify the driver to shift.

The "Dial-In-Exactness" feature utilizes the tach's fluorescent red pointer to indicate the chosen rpm. By turning a set knob on the tach face the pointer sweeps up or down until the preferred rpm is selected. The rpm can be checked at anytime by simply switching the knob to Set. Part #3906 includes peak rpm memory. The driver can switch to Recall on the tach face and the highest rpm achieved will be displayed by the pointer. The All Silver Sport-Comp 5" Monster Tach is modeled after the popular Ultra-Lite series, but at a more affordable price. The new "Silver" tach includes silver painted steel mounting cups with an anodized aluminum dial, bezel and control shield - matching the Ultra-Lite hot race look!



3906



3910



3903

3904

3905

PART #	DESCRIPTION	PRICE
3903	5" 10,000 RPM SHIFT-LITE TACH	\$169.07
3904	5" 10,000 RPM SHIFT-LITE TACH*	\$185.27
3905	5" 8,000 RPM SHIFT-LITE TACH*	\$185.27
3906	5" 10,000 RPM SHIFT-LITE MEMORY TACH*	\$259.58
3910	5" 10,000 RPM SILVER MONSTER TACH	\$153.03
3911	5" 10,000 RPM SILVER SHIFT-LITE TACH*	\$224.07

* With Dial-In-Exactness



SPECIAL QUALITY FEATURE!

5" MONSTER & 3-3/4" SPORT-COMP TACHOMETERS

The "Monster" sized tachometers feature an air core meter movement and advanced electronic circuitry that provide accuracy and fast action response. The 5" dial face provides maximum readability and adjustable red line shift marker helps driver to maintain proper shift points. The rubber lined shock mounting strap absorbs the rough pounding and vibrations in sportsman racing.

The 3-3/4" tachometers with the classic "tough" appearance has become the standard competition instrument in automotive motorsports. Also available in the 2-5/8" size for Junior Dragsters.



3900



3980



LARGE DIAMETER GAUGES



3700

3780

6651

PART #	DESCRIPTION	PRICE
3900	5" 10,000 RPM MONSTER TACH	\$121.55
3980	5" 8,000 RPM MONSTER TACH	\$121.55
3700	3-3/4" 10,000 RPM STANDARD TACH	\$105.68
3780	3-3/4" 8,000 RPM STANDARD TACH	\$105.68
6651	2-5/8" 8,000 RPM MINI JR. DRAG TACH*	\$94.66
6652	2-5/8" 10,000 RPM MINI JR. DRAG TACH*	\$94.66

* Operates on Briggs & Stratton engine only, requires external dry cell battery.

PRO COMP & ULTRA-LITE SERIES 5" & 3-3/4" IN-DASH TACHOMETERS & SPEEDOMETERS

For custom automotive builders insisting on the finest in racing instruments, these speedometers and tachs complete the Pro Street dashboard. They are designed to match either the Ultra-Lite aluminum gauges or the Pro Comp gauges. The tach includes a rugged air core meter movement for accurate, fast action response. The speedometer includes a trip odometer to help measure mileage. Two sizes are available to match most dashboard size requirements.

ULTRA-LITE SERIES

PART #	DESCRIPTION	PRICE
4492	3-3/8" 120 MPH IN-DASH MECH SPEEDOMETER	\$79.88
4495	5" 160 MPH IN-DASH MECH SPEEDOMETER	\$123.35
4497	3-3/8" 10,000 RPM IN-DASH ELEC TACH	\$94.83
4498	5" 10,000 RPM IN-DASH ELEC TACH	\$132.74

PRO COMP SERIES

PART #	DESCRIPTION	PRICE
5152	3-3/8" 120 MPH IN-DASH MECH SPEEDOMETER	\$73.02
5154	5" 160 MPH IN-DASH MECH SPEEDOMETER	\$111.59
5160	5" 10,000 RPM IN-DASH ELEC TACH	\$123.66
5161	3-3/8" 10,000 RPM IN-DASH ELEC TACH	\$88.35



4495

4498



5154

5160



4492

4497

5" IN-DASH MEMORY ULTRA-LITE TACHOMETERS 5" WATER RESISTANT PRO COMP MEMORY TACH

Ultra-lite aluminum models featuring peak memory recall, allowing drivers to record their highest rpm attained during a race. The dual-range version utilizes a professional dial design that emphasizes the critical racing rpm range.

Water resistant Pro Comp tach models include a high quality water proof switch. These models also include the unique rpm memory feature. Can use mt. strap #3209.

5" ULTRA-LITE GAUGES

PART #	DESCRIPTION	PRICE
4494	10,000 RPM SINGLE RANGE MEMORY TACH	\$212.78
4499	10,000 RPM DUAL RANGE MEMORY TACH	\$214.14

5" PRO-COMP WATER RESISTANT GAUGES

PART #	DESCRIPTION	PRICE
6801	10,000 RPM IN-DASH MEMORY TACH (STD/ELEC)	\$206.78
6802	10,000 RPM IN-DASH MEMORY TACH (VERTEX OAC)	\$220.04
6803	10,000 RPM IN-DASH MEMORY TACH (SUPER MAG)	\$236.41



4494

4499



6801/6802/
6803

3-3/4" & 5" PRO COMP MEMORY TACHOMETERS

3-3/4" dia. and 5" monster memory tachs utilize peak rpm Memory recall - helpful in setting gear ratios and reviewing drivers shifting accuracy. Available in three models for different racing ignitions.

PART #	DESCRIPTION	PRICE
5610	3-3/4 " 10,000 RPM TACH (STD/ELEC)	\$142.49
5620	3-3/4" 10,000 RPM TACH (VERTEX OAC)	\$148.50
6601	3-3/4" 10,000 RPM MEMORY TACH (STD/ELEC)	\$198.99
6602	3-3/4" 10,000 RPM MEMORY TACH (VERTEX OAC)	\$214.07
6603	3-3/4" 10,000 RPM MEMORY TACH (SUPER MAG)	\$229.53
6809	5" 9,000 RPM MEMORY TACH (STD/ELEC)	\$186.72
6811	5" 11,000 RPM MEMORY TACH (STD/ELEC)	\$186.72
6821	5" 11,000 RPM MEMORY TACH (VERTEX OAC)	\$200.43
6831	5" 11,000 RPM MEMORY TACH (SUPER MAG)	\$210.65



5610



6809



6603

6602

6601

PRO COMP 2 SERIES**5" PRO COMP 2 TACHOMETERS**

The Pro Comp 2 tachometers, in traditional black or the all aluminum Ultra-Lite version, include a two-stage shift light. This two-stage light gives the driver two shift settings to allow the first gear a different rpm shift point than the remaining gears. The bright red "Quick Lite" along with the Dial-In-Exactness feature gives instantaneous notice of shift points to provide faster response times during shifts. High and fast revving cars utilize the Dual Range models, which feature a dial face that expands the most critical racing rpm range. Peak rpm Memory Recall reviews the highest rpm achieved during a race.

**5" PRO COMP 2 TACHS**

PART #	DESCRIPTION	PRICE
6859	11,000 RPM MEMORY SINGLE RANGE SHIFT-LITE TACH (MECH/ELEC - MALLORY SUPER MAG APPLICATIONS)	\$330.69
6851	9,000 RPM MEMORY SINGLE RANGE SHIFT-LITE TACH	\$278.92
6852	9,000 RPM MEMORY DUAL RANGE SHIFT-LITE TACH	\$280.29
6853	11,000 RPM MEMORY DUAL RANGE SHIFT-LITE TACH	\$280.29

5" PRO COMP 2 ULTRA-LITE TACHS

PART #	DESCRIPTION	PRICE
6854	9,000 RPM MEMORY DUAL RANGE SHIFT-LITE TACH	\$294.32
6855	11,000 RPM MEMORY DUAL RANGE SHIFT-LITE TACH	\$294.32
6856	9,000 RPM MEMORY SINGLE RANGE SHIFT-LITE TACH	\$294.32

5" PRO COMP 2 PLAYBACK TACHOMETERS

The Pro Comp 2 Playback tachometers allow the replay to be viewed in both half speed or full speed. Drag race teams can store several runs and review them at their convenience later. Specific features include:

Automatic Record Memory Start "ARMS": The recording is started by the normal release of the line-lock or trans-brake so the LED Playback time clock begins recording at the launch.

Two-Stage Shift Light: Allows for the fast revving first gear to be set at a lower rpm than the rest of the shifts. The LED Quick-Lite along with the Dial-In-Exactness feature gives instantaneous notice.

Four Recordings, 40 second each memory: Store up to 4 separate runs up to 40 seconds ea.

Peak Shift Catcher: During playback, the tach can automatically freeze the pointer and LED clock at each gear shift. This allows ample time to record shift points and time between each shift.

Time Elapsed Clock: Large bright LED indicates time elapsed in .01 second increments during the race or Playback.

Printer Output Capability: With the use of model 9140 Printer Interface, listed below, the recording can be downloaded to a printer.

Peak RPM Control: The highest rpm that occurred can be viewed both during the race or Playback.

Remote Control Module: An optional 8' extension cable, model 5220, allows the control to be moved so the driver or crew can operate the Playback features in a convenient location.

Start-Stop Control: "Start" and "Stop" control buttons permit playback rpm and ET to be "Frozen" manually, at any point in the run, for easy reading of data.



PART #	DESCRIPTION	PRICE
6861	9,000 RPM SINGLE RANGE PLAYBACK TACH	\$363.52
6871	9,000 RPM SINGLE RANGE ULTIMATE PLAYBACK TACH	\$481.47

PRO-SHIFT LITE

The Pro-Shift is an independently operating shift light with advanced microcircuitry. The shift-point is selected by inserting a precisely calibrated rpm module "Pill" into the unit. The amber light activates when the engine reaches the chosen rpm. A variety of clearly marked rpm module "Pills" are available. **Note: #5340 may be adjusted to 4-6-8 cyl. #5341 & #5342 are fixed to 8-cyl, but may be used on 4 or 6-cyl by using less chip. For example, 4-cyl. installation with 3,000 rpm chip will "light up" at 6,000 rpm.**



QUICK-LITE SHIFT-LITE

This LED shift light is a replacement option on Auto Meter tachometers with the larger size light or any other accessory RPM triggering device.



REF	PART #	DESCRIPTION	PRICE
A	5340	PRO-SHIFT LITE (STD/ELEC)	\$74.89
A	5341	PRO-SHIFT LITE (VERTEX OAC)	\$78.80
A	5342	PRO-SHIFT LITE (VERTEX OXC/SUPER MAG)	\$100.43
-	5353	3000 RPM MODULE KIT*, 3,000 - 3,800	\$22.98
-	5354	4000 RPM MODULE KIT*, 4,000 - 4,800	\$22.98
-	5355	5000 RPM MODULE KIT*, 5,000 - 5,800	\$22.98
-	5356	6000 RPM MODULE KIT*, 6,000 - 6,800	\$22.98
-	5357	7000 RPM MODULE KIT*, 7,000 - 7,800	\$22.98
-	5358	8000 RPM MODULE KIT*, 8,000 - 8,800	\$22.98
-	5359	9000 RPM MODULE KIT*, 9,000 - 9,800	\$22.98
-	5360	10,000 RPM MODULE KIT*, 10,000 - 10,800	\$22.98
-	5361	11,000 RPM MODULE KIT*, 11,000 - 11,800	\$22.98
B	5330	QUICK-LITE SHIFT LITE	\$36.47

* Each kit contains five chips

2-5/8" PYROMETER

In professional racing applications a superior quality pyrometer is required to measure cylinder head or exhaust gas temperatures. These Pyrometers feature fast responding rugged meter movements. Probe is required for operation of Pyrometer gauge.



PART #	DESCRIPTION	PRICE
6561	PYROMETER (0-1600° F.)	\$95.14
5246	3/16" DIA. STAINLESS RACING PROBE (10")	\$62.26
6562	CYL HEAD TEMP (0-600° F.)	\$95.14
5248	CYLINDER HEAD TEMP PROBE, 6 FT. WIRE	\$56.96



TACH PLAYBACK RECORDER & PRINTER INTERFACE

Converts any Auto Meter tachometer, except Magneto type, into a Playback recording device. Full runs can be replayed at full or half speed and viewed on a LED clock (included). Features include:

- ARMS "Automatic Record Memory Start"
- Time Elapsed Clock
- Four Recordings, 40 Seconds Each Memory Block
- Printer Output Capability

The Printer Interface directly downloads a Playback tach, Playback Recorder, or LTM to a printer without the need for a computer. Printer requirements are for almost any format emulating the Epson 9 or 24 pin dot matrix. Printer will operate with the 9140 Interface.



PART #	DESCRIPTION	PRICE
9150	TACH PLAYBACK RECORDER	\$328.53
9140	PRINTER INTERFACE FOR PLAYBACK TACH/RECORDER	\$262.81

PRO-LITE WARNING LIGHT MINI PRO LIGHT

Gives you unmistakable warning in the midst of racing action when there is no time to monitor gauges - 1-5/8" dia. lens x 5" long. Mini Pro-Lite measures 5/8" dia. x 3-1/2" long. *Note: Pro-Lite should be used in conjunction with gauge to give first alert to potential problems.*



REF	PART #	DESCRIPTION	PRICE
B	3238	MINI PRO-LITE, SILVER	\$31.38
C	3239	MINI PRO-LITE, BLACK	\$30.83
A	3240	PRO-LITE (RED LENS)	\$30.22
D	3241	PRESSURE SENDER (15 PSI)	\$19.23
D	3242	PRESSURE SENDER (30 PSI)	\$19.23
D	3243	PRESSURE SENDER (50 PSI)	\$19.23
E	3246	TEMP SENDER (187°-203° F, BLUE LENS)	\$21.32
E	3247	TEMP SENDER (210°-230° F, BLUE LENS)	\$21.32
-	3250	BLUE LENS KIT	\$7.75
-	3251	YELLOW LENS KIT	\$7.75
-	3252	RED LENS KIT	\$7.75



PRO-CONTROL RPM CONTROL UNIT

Can be used as rev-limiter, air shift activator or nitrous oxide trigger. As rev-limiter, it guards against over-revving by allowing 100% power until reaching the pre-set rpm level. Models without reset button interrupt ignition power for a fraction of a second. Models with reset button are for super-charged (blown) engines. Reset unit shuts off engine completely.



"IGNITION INTERRUPTOR" MODELS (W/O RESET)

PART #	DESCRIPTION	PRICE
5301	STD/ ELEC IGNITION	\$117.25
5302	VERTEX OAC/ MSD PRO MAG IGNITION	\$120.70
5308	VERTEX OAC/ IGNITION (W/ BYPASS DELAY)	\$149.18
5309	VERTEX OXC OR SUPER MAG IGNITION (W/ BYPASS DELAY)	\$158.53

"SHUT DOWN" MODELS (W/RESET)

PART #	DESCRIPTION	PRICE
5305	VERTEX OAC/ MSD PRO MAG	\$133.48
5306	VERTEX OXC/ SUPER MAG (W/ BYPASS DELAY)	\$142.85

TIRE PRESSURE GAUGE

Accurate repetitive readings can be recorded with this rugged Auto Meter tire gauge. Wide range of operation, 0 - 60#, holds reading until reset button is depressed.



PART #	DESCRIPTION	PRICE
2343	TIRE PRESSURE GAUGE	\$24.92

INSTRUMENT COVER

Fits 5" Sport-Comp and Pro Comp Monster Tachometers, without Shift Lite. Protects tach from elements.



PART #	DESCRIPTION	PRICE
5241	INSTRUMENT COVER	\$29.30

ACCESSORIES

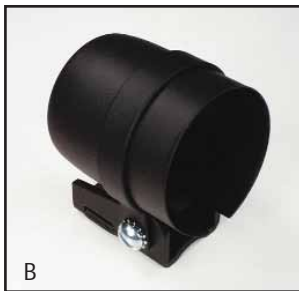
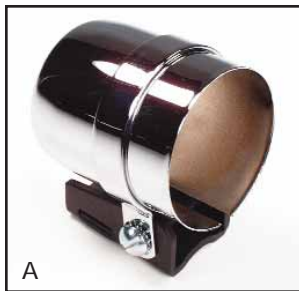

2-1/16" PERFORMANCE GAUGE ACCESSORIES

REF	PART #	DESCRIPTION	PRICE
A	2203	CHROME CUP	\$19.92
B	2204	BLACK CUP	\$12.25
-	2237	2-HOLE BLACK ALUM GAUGE PANEL (2-1/16")	\$10.28
C	2242	REPL SENDER ELEC OIL PRESS (100#)	\$28.65
D	2254	REPL SENDER ELEC TEMP (PRE-1995)	\$13.87
D	2258	REPL SENDER ELEC TEMP (1995 & AFTER)	\$13.87
D	2259	REPL SENDER CYL HEAD TEMP - 340° (1995 & AFTER)	\$10.35

2-5/8" GAUGE CUPS

REF	PART #	DESCRIPTION	PRICE
A	3201	CHROME CUP (ALL ELEC GAUGES)	\$20.88
B	3202	BLACK CUP (ALL ELEC GAUGES)	\$12.41
A	3203	CHROME CUP (MECH TEMP/ PRESS GAUGES)	\$20.88
B	3204	BLACK CUP (MECH TEMP/ PRESS GAUGES)	\$12.41

2-5/8" LIQUID FILLED GAUGE CUPS

REF	PART #	DESCRIPTION	PRICE
A	5201	CHROME MOUNTING CUP*	\$20.43
B	5202	BLACK MOUNTING CUP*	\$14.63

* Fits Both Pressure or Temp Gauges

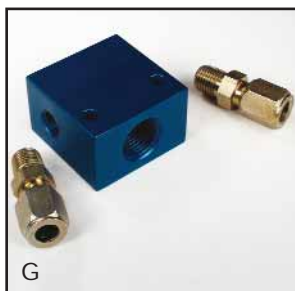

MISC. GAUGE ACCESSORIES

REF	PART #	DESCRIPTION	PRICE
F	2265	ADAPTER 1/8 NPT FEMALE TO 10MM MALE	\$10.09
G	2286	TRANS TEMP ADAPTER, 3/8" OD TUBE	\$29.38
G	2287	TRANS TEMP ADAPTER, 5/16" OD TUBE	\$29.38
H	3209	TACH SHOCK STRAP KIT	\$14.75
I	3214	(3) BULB BOOTS, RED	\$3.25
I	3215	(3) BULB BOOTS, GREEN	\$3.25
E	3226	NYLON TUBING KIT 1/8" DIA.	\$9.51
J	3257	3' EXTENSION WIRE, QUICK LITE	\$15.37
K	3262	FUEL GAUGE SENDER (240 OHMS EMPTY/33 OHMS FULL)	\$28.68
-	5215	BEI- LASER ADAPTER	\$16.00
L	5210	INDUCTIVE TRIGGER	\$37.02
-	5220	8' EXTENSION WIRE, PLAYBACK TACHS	\$35.67

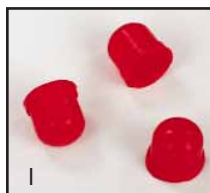



painless

Painless is the number one name in high quality wiring harnesses for racing and street performance applications. Their system approach makes installation easy, and their kits include comprehensive instructions. Painless uses a special non-kink

wire that is abrasion resistant and each wire is marked and color-coded for the application. Painless Wiring Kits are the best choice for both professionals and do-it-yourselfers.



RACE CAR WIRING ASSEMBLY

This 8-circuit wiring harness with pre-terminated fuse block features heavy duty 30 amp relays for circuit applications including:

- Start
- Ignition
- Electric Fuel Pump #1
- Lights
- Electric Fan
- Electric Fuel Pump #2
- Accessory Circuit
- Electric Water Pump

PART #	DESCRIPTION	PRICE
P50001	RACE CAR WIRING ASSEMBLY	\$276.49



CHARGING SYSTEM SHUTDOWN RELAY KIT

Even with the master disconnect turned off, your engine may continue to run due to alternator feedback. This relay is installed between the alternator and the battery. When master disconnect is switched off, the relay is de-energized and stops current flow to the ignition system. Kit is supplied with all installation hardware and easy to follow installation instructions.

PART #	DESCRIPTION	PRICE
P50103	SHUTDOWN RELAY KIT	\$36.45



12 CIRCUIT FUSE CENTER

This street legal fuse center, designed and built especially for racing, locates the following fuses in one convenient location:

- Brake Lights
- Coil
- Dome Light
- Electric Fan
- Electric Fuel Pump
- Electric Water Pump
- Emergency Flashers
- Headlights
- Horn
- Instruments
- Radio
- Turn Signals
- Wipers

Features 10 gauge lead-in wire for powering-up circuits.

PART #	DESCRIPTION	PRICE
P50101	RACE CAR FUSE CENTER	\$139.16



LIGHTED AND FUSED SWITCH PANELS WITH COMPLETE WIRING SYSTEMS

Designed for racing applications, these panels feature lighted rocker switches and a heavy-duty, non-reflective, lightweight metal housing. Each switch function is screen-printed for quick visual reference. All circuits are individually fused with automotive blade-type fuses mounted on bottom of housing for quick testing and changing. May be dash or roll bar mounted.

PART #	HEIGHT	WIDTH	DEPTH	# OF SWITCHES	SWITCH FUNCTIONS	PRICE
P50301	3"	5-3/4"	3-1/8"	4	START,IGNITION, ACCESSORY*, ACCESSORY	\$136.53
P50302	3"	8-1/4"	3-1/8"	6	START, IGNITION, ELECTRIC FAN, FUEL PUMP/WATER PUMP, ACCESSORY*, ACCESSORY*	\$200.20
P50303	3"	10-3/4"	3-1/8"	8	START, IGNITION, ELECTRIC FAN, FUEL PUMP#1*, FUEL PUMP#2*, WATER PUMP, LIGHTS, ACCESSORY*	\$260.72

* For safety, these switches are only powered on when the ignition is on.



painless

UNIVERSAL FUEL PUMP RELAY KIT

Prevents voltage drops, while maintaining constant fuel pump pressure and saves electrical system damage from amperage overloads. Suggested for street applications and a must for racing.

PART #	DESCRIPTION	PRICE
P50102	ELECTRIC FUEL PUMP RELAY	\$26.71



FUSED VERTICAL DRAGSTER SWITCH PANEL

With space in the dragster cockpit at a premium, the Vertical 6 Switch Dragster Control Center is the perfect solution. With a wafer-thin 1-1/2" width (15-1/2" length/2-1/2" depth), this self-contained control center mounts in virtually any position and provides immediate control of connected electrical functions. Switch functions include:

- Start
- Ignition
- Fuel Pump
- Water Pump
(fan & water pump/center off/water pump only)
- Accessory
- Accessory

Standard features include color-coded rocker switches that light up (except start) when pushed and screen printing on all switch functions on top and bottom for quick visual reference and to provide for a greater number of mounting configurations. Designed for easy hose clamp mounting (clamps not supplied), either vertically or horizontally, on the frame or rollbar.

PART #	DESCRIPTION	PRICE
P50506	FUSED DRAGSTER 6-SWITCH PANEL	\$209.72



REPLACEMENT ROCKER SWITCHES

These replacement rocker switches work for all Painless switch panels or for special applications requiring the Painless sleek looking rocker switch. Available with or without lighting.

PART #	DESCRIPTION	PRICE
P80400	MOMENTARY ON, NON-LIGHTED	\$9.36
P80401	ON/OFF, RED LIGHT	\$10.64
P80402	ON/OFF/MOMENTARY ON, GREEN LIGHT	\$13.60
P80403	ON/OFF/ON, RED LIGHT	\$13.17
P80404	ON/OFF, AMBER LIGHT	\$10.64
P80405	ON/OFF, BLUE LIGHT	\$10.64

12-CIRCUIT FUSE CENTER

Now available for connection to your existing vehicle wiring, or for use as a starting point for custom wiring. This OEM specification-grade fuse block center is supplied with a mounting plate for fast, permanent installation. Includes wiring provisions for:

- Air Conditioning and/or Heat
- Brake Lights
- Coil (anti-theft feature)
- Dome Light
- Electric Fan
- Emergency Flashers
- Gauges/Dash Instruments
- Headlights
- Horn
- Radio (ignition hot)
- Turn Signals
- Wipers

PART #	DESCRIPTION	PRICE
P30001	12 CIRCUIT FUSE CENTER	\$101.00



CIRKIT BOSS FUSE CENTERS

CirKit Boss Fuse Centers provide the ideal cost-effective solution when additional electrical circuits are required, or accessory equipment requires ignition hot and constant hot capabilities. **CirKit Boss is the only add-on fuse center available in the marketplace with ignition hot capabilities.** This safety feature ensures that your add-on circuits will only work if the ignition key is on.

PART #	# OF CIRCUITS	TYPE OF CIRCUITS*	PRICE
P70103	3	2 IGNITION HOT 1 CONSTANT HOT	\$35.30
P70107	7	4 IGNITION HOT 3 CONSTANT HOT	\$43.04

* Ignition hot circuits are hot only when the key is turned on
Constant hot circuits are always hot.



CIRKIT BOSS WITH WEATHERPROOF KIT

These new cirkit bosses offer the same features as the standard cirkit boss kit with weather sealed back and rubber fuse boot for additional protection.



PART #	# OF CIRCUITS	TYPE OF CIRCUITS*	PRICE
P70203	3	2 IGNITION HOT 1 CONSTANT HOT	\$45.12
P70207	7	4 IGNITION HOT 3 CONSTANT HOT	\$56.75

* Ignition hot circuits are hot only when the key is turned on, constant hot circuits are always hot.

4-CIRCUIT FUSE CENTER

This universal Fuse Block is supplied in easy-to-assemble kit form, and can be used for just about any automotive-type electrical application. Ideal for in-line wiring applications such as trailer wiring, or when adding vehicle accessories. Uses blade-type automotive fuses (not supplied), up to 30 amps.



PART #	DESCRIPTION	PRICE
P30002	4-CIRCUIT FUSE CENTER	\$5.14

EXTREME CONDITION WIRE

Multi stranded copper core covered with cross-linked polyethylene insulation for superior abrasion resistance. Withstands over 275 degrees.



PART #	DESCRIPTION	PRICE
P70700	10 GAUGE RED 25'	\$10.75
P70701	10 GAUGE BLACK 25'	\$12.98
P70800	14 GAUGE RED 50'	\$13.47
P70801	14 GAUGE BLACK 50'	\$11.58
P70802	14 GAUGE ORANGE 50'	\$13.47
P70803	14 GAUGE YELLOW 50'	\$11.58
P70804	14 GAUGE GREEN 50'	\$11.58
P70805	14 GAUGE BLUE 50'	\$11.58
P70806	14 GAUGE WHITE 50'	\$11.58
P70807	14 GAUGE GRAY 50'	\$11.58
P70808	14 GAUGE LT BLUE 50'	\$16.77
P70809	14 GAUGE LT GREEN 50'	\$13.47
P70810	14 GAUGE PINK 50'	\$11.58

INDICATOR LAMP ASSEMBLIES

Replace that burned-out indicator light with an OEM-grade Indicator Lamp Assembly! Applications include turn signal indicators, high beam headlight indicator, "idiot lights," oil pressure, water temperature, etc. Available in 1/8" & 5/16" diameters with 5" long wire leads.



PART #	DESCRIPTION	PRICE
P80200	1/8" DASH INDICATOR LIGHT/AMBER	\$4.88
P80201	1/8" DASH INDICATOR LIGHT/RED	\$4.38
P80202	1/8" DASH INDICATOR LIGHT/GREEN	\$4.85
P80203	5/16" DASH INDICATOR LIGHT/AMBER	\$5.25
P80204	5/16" DASH INDICATOR LIGHT/RED	\$5.22
P80205	5/16" DASH INDICATOR LIGHT/GREEN	\$5.22
P80206	5/16" DASH INDICATOR LIGHT/BLUE	\$5.22

MASTER CUT-OFF SWITCH WITH LEVER

This heavy duty battery disconnect kit includes mount bracket and 18" long remote rod and tee handle.



PART #	DESCRIPTION	PRICE
C72-028	MASTER CUT-OFF SWITCH WITH LEVER	\$79.90

MASTER CUT-OFF SWITCH

Master cut-offs are not only a good idea, they are required by most sanctioning bodies. Spliced into the positive battery cable this heavy duty switch positively shuts off all electrical current. Rated at 175 amps continuous.



PART #	DESCRIPTION	PRICE
C72-025	MASTER CUT-OFF SWITCH	\$38.90

JAMB TAC™ WIRELESS CONNECTORS

No more running wires through doorjamb when installing your stereo system, power windows, or power locks! Mounts anywhere on doorjamb.



PART #	DESCRIPTION	PRICE
P40021	ONE CONTACT	\$11.50
P40022	TWO CONTACT	\$14.61
P40023	THREE CONTACT	\$20.70
P40024	FOUR CONTACT	\$26.48

QUICK CONNECT TERMINAL KITS

Make your own locking quick connect plugs easily and quickly. Each kit is supplied with one male and one female connector and the appropriate number of quick connect wire terminals. Now available in Standard or Weatherproof style.



STANDARD			WEATHERPROOF		
PART #	DESCRIPTION	PRICE	PART #	DESCRIPTION	PRICE
P40006	2-WIRE CAPACITY	\$3.01	P70401	1-WIRE CAPACITY	\$8.32
P40007	3-WIRE CAPACITY	\$5.18	P70402	2-WIRE CAPACITY	\$5.30
P40008	4-WIRE CAPACITY	\$5.18	P70403	3-WIRE CAPACITY	\$6.70
P40009	6-WIRE CAPACITY	\$6.18	P70404	4-WIRE CAPACITY	\$7.94
P40010	9-WIRE CAPACITY	\$6.38	P70406	6-WIRE CAPACITY	\$9.73
P40011	12-WIRE CAPACITY	\$8.26			
P40012	15-WIRE CAPACITY	\$6.78			

WATERPROOF SWITCHES

Long life 12 volt toggle switches are waterproof, sealed and include dust boot. Rated at 20 amps.



REF	PART #	DESCRIPTION	PRICE
B	P80503	PUSH BUTTON START	\$14.18
A	P80530	WATERPROOF TOGGLE ON/OFF SINGLE POLE	\$17.33
A	P80532	WATERPROOF TOGGLE ON/OFF/ON SINGLE POLE	\$18.53
A	P80533	WATERPROOF TOGGLE ON/OFF DOUBLE POLE	\$21.33
A	P80534	WATERPROOF TOGGLE ON/OFF/ON DOUBLE POLE	\$24.96
-	P80520	REPL. TOGGLE SWITCH BOOT	\$7.15

REMOTE BATTERY TERMINALS

May be positioned inside or outside of car for convenient connection to battery charger. Accepts 6 to 36 volt.



PART #	DESCRIPTION	QTY.	PRICE
C72-022	REMOTE BATTERY TERMINALS	2	\$37.75

BATTERY COUPLER

This quick-disconnect battery coupler is compact and easily connected. Bright red with 175 amp/600V maximum capacity.

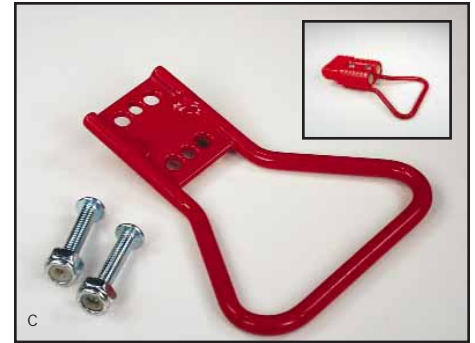
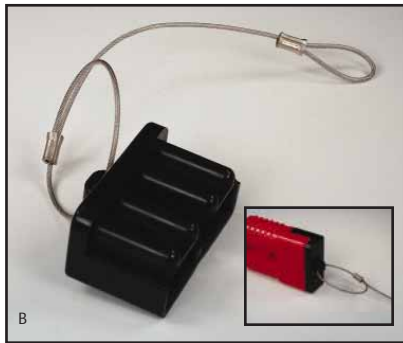
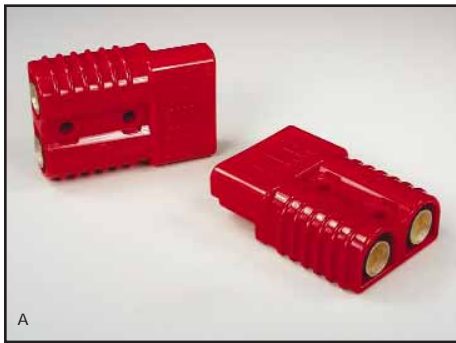

REF	PART #	DESCRIPTION	PRICE
A	C72-020	BATTERY COUPLER (EA)	\$12.95
A	C72-021	BATTERY COUPLER (PR)	\$25.90
B	C72-023	DUST COVER	\$10.95
C	C72-029	HANDLE	\$15.95



STARTER RELAY

This starter relay permits the vertex magneto to be controlled by a standard automotive type ignition switch - making the extra ground switch unnecessary.

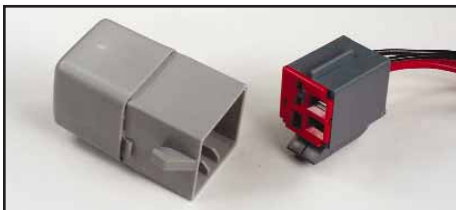

PART #	DESCRIPTION	PRICE
V925010	STARTER RELAY	\$24.69

TIMING BOX

The latest in digital intergated circuitry is incorporated in this tool, for accurate initial timing setting of all magnetos.



PART #	DESCRIPTION	PRICE
V607980	TIMING BOX	\$68.60

MAGNETO IGNITION WIRES

Universal red wire set includes eight ignition leads with spark plug boot on one end - other end for insertion into Vertex cap. Wire core is preferred for magneto applications. Fits both OXC and OAC versions.



90°



Straight

PART #	DESCRIPTION	PRICE
V070264	STRAIGHT	\$47.20
V070260	90 DEGREE	\$47.20

MAGNETO REPLACEMENT PARTS



PART #	DESCRIPTION	PRICE
V916510	OAC CAP - 4 CYL	\$36.25
V916511	OXC CAP - 4 CYL	\$47.64
V916550	OAC CAP - 8 CYL	\$48.40
V916551	OXC CAP - 8 CYL	\$54.32
V911090	OXC COIL	\$149.40
V912100	CONDENSER	\$11.60
V916401	ROTOR - 4 CYL	\$19.75
V916402	ROTOR - 8 CYL	\$19.75
V906850	CONTACT POINT SET	\$75.01
V602900	DEGREE RING	\$30.10
V918030	FIXED ADVANCE KIT	\$11.41



stroud

For over 15 years, the Stroud name has meant quality and performance in the safety field of racing. Their unique tri-form design parachutes provide easier packing and a softer stop than that of large quad-form designs. That means more control for your

stops and less hassle getting ready for the next run. Stroud pioneered "Launcher" technology and has built a reputation around quality materials and craftsmanship. We carry Stroud because we know safety must always be the number one concern of every driver.

Professional parachute engineers with over 25 years of experience design stroud chutes. The unique tri-form design launches easier and opens softer than older quad-form designs. A complete set of illustrated maintenance and packing instructions are included with every Stroud parachute. Our standard stocking color is black. Other color choices of red, blue, white, hot pink, orange, or yellow may be special ordered. Also available on every chute listed is the optional launcher upgrade. The launcher eliminates the need for the pilot chute. These spring loaded or CO₂ activated versions are easy to load and provide positive chute deployment. All chutes require a cable for releasing (see Pg. 49).



PART #	DESCRIPTION	PRICE
4011	JR DRAGSTER	\$105.00
4001	SUPER COMP	\$220.00
4001-L*	SUPER COMP W/ LAUNCHER OPTION	\$470.00
4001-V	VW SEDAN	\$250.00
4001-VL*	VW SEDAN W/ LAUNCHER OPTION	\$500.00
4101	SUPER GAS	\$250.00
4101-L*	SUPER GAS W/ LAUNCHER OPTION	\$500.00
4201	COMP ELIMINATOR	\$265.00
4201-L*	COMP ELIMINATOR W/ LAUNCHER OPTION	\$515.00
4301	PRO STOCK	\$305.00
4301-L*	PRO STOCK W/ LAUNCHER OPTION	\$555.00
4501	FUEL RAIL	\$355.00
4501-L*	FUEL RAIL W/ LAUNCHER OPTION	\$605.00
4701	FUEL FUNNY	\$375.00
4701-L*	FUEL FUNNY W/ LAUNCHER OPTION	\$620.00

*Specify Spring or CO2 Launcher



stroud

TECH TIP

Parachutes serve two useful functions:

- 1) to slow you down
- 2) to keep your car straight.

Make it a practice of releasing your parachute every time you cross the finish line - if you wait until you are out of control, it may be too late (at 150 mph you will travel 300 ft. before your chute becomes effective.)



Chute size requirements are based on the type of car, weight, and speed. Correct chute selection is very important. Call us if help is needed.

REPLACEMENT PARTS

We stock many replacement parts to maintain your Stroud parachute.



PART #	DESCRIPTION	PRICE
471	SMALL PILOT CHUTE (7-1/4" DIA SPRING)	\$59.00
472	LARGE PILOT CHUTE (8" DIA SPRING)	\$64.00
473	PACK BAG	\$45.00
474	FIREPROOF PACK BAG	\$70.00

PARACHUTE MOUNT KIT

Universal chromoly mount kit can be mounted to rear end on dragster or back of door car to provide secure support for most parachutes available. Measures 7-1/4" x 7-1/4" and includes 16" support tubes shown.



PART #	DESCRIPTION	PRICE
C72-200	PARACHUTE MOUNT KIT	\$45.95

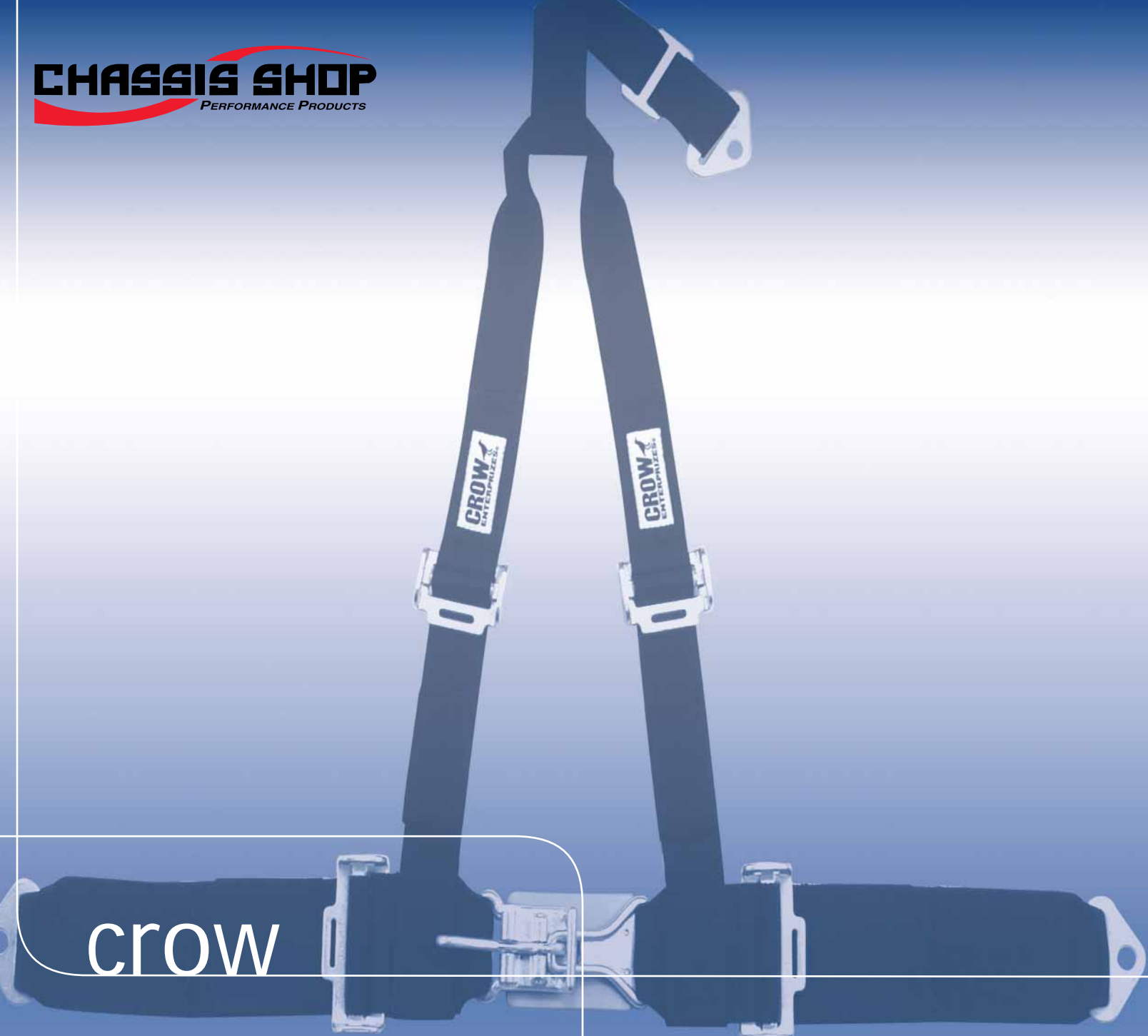

crow

Crow Enterprises has quickly established itself as a leader in safety equipment manufacturing. They understand the racer's needs of safety, comfort and performance and have developed products that you can find in the highest

forms of racing: NASCAR, NHRA, IHRA, CART, SCCA, and USAC. All products meet or exceed SFI-16 specifications and are 100% made in the USA. Available in gray, blue, red, and black.



High quality Crow restraints are assembled with the best hardware and webbing available. Each restraint is backed by years of safety equipment experience.

LATCH AND LINK RESTRAINTS

These 5-way driver restraints feature a 55" long 3" wide seat belt with pull down adjustment and built in latch guard. Each set includes a 2" wide anti-submarine belt and 3" wide shoulder harness. Meets SFI 16.1 specification.

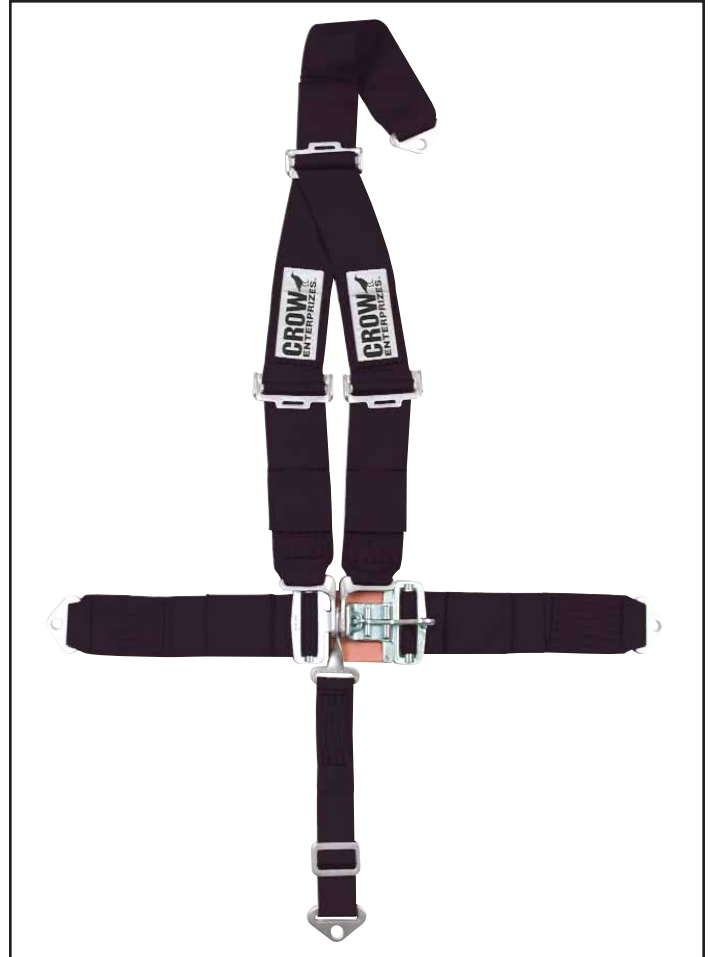

TWIN HARNESS		
PART #	DESCRIPTION	PRICE
C11062	RED, BOLT IN W/ TWIN HARNESS	\$74.95
C11063	BLUE, BOLT IN W/ TWIN HARNESS	\$74.95
C11064	BLACK, BOLT IN W/ TWIN HARNESS	\$74.95
C11067	GRAY, BOLT IN W/ TWIN HARNESS	\$74.95

Y HARNESS		
PART #	DESCRIPTION	PRICE
C11082	RED, BOLT IN W/ Y HARNESS	\$76.95
C11083	BLUE, BOLT IN W/ Y HARNESS	\$76.95
C11084	BLACK, BOLT IN W/ Y HARNESS	\$76.95
C11087	GRAY, BOLT IN W/ Y HARNESS	\$76.95

CROW RESTRAINT COLOR OPTIONS

All Crow restraints featured in this catalog are available in your choice of these four colors.

Racers: Be sure to request current dates on restraints when ordering.



Black



Red

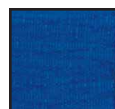

Blue



Gray

ROTARY CAM LOCK

The precision Rotary Cam Lock system is considered the top of the line in driver restraint systems. With a 50" long, 3" wide seat belt, these 5-way driver restraints include a 3" shoulder harness and a 2" anti-submarine belt. Meets SFI 16.1 specifications.



TWIN HARNESS

PART #	DESCRIPTION	PRICE
C11102	RED, BOLT IN W/ TWIN HARNESS	\$144.96
C11103	BLUE, BOLT IN W/ TWIN HARNESS	\$144.96
C11104	BLACK, BOLT IN W/ TWIN HARNESS	\$144.96
C11107	GRAY, BOLT IN W/ TWIN HARNESS	\$144.96

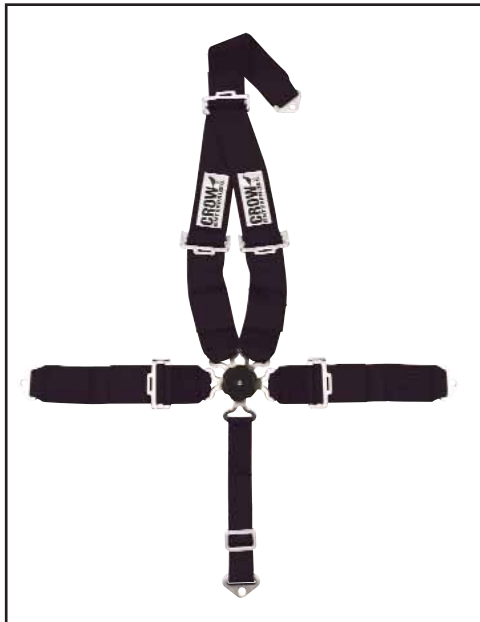

Y HARNESS

PART #	DESCRIPTION	PRICE
C11122	RED, BOLT IN W/ Y HARNESS	\$144.96
C11123	BLUE, BOLT IN W/ Y HARNESS	\$144.96
C11124	BLACK, BOLT IN W/ Y HARNESS	\$144.96
C11127	GRAY, BOLT IN W/ Y HARNESS	\$144.96

PRO DRAG RESTRAINT

This racing version features rotary cam lock release and wrap around attachment. Covered with flame retardant material for extra protection. Meets SFI 16.1 specification.

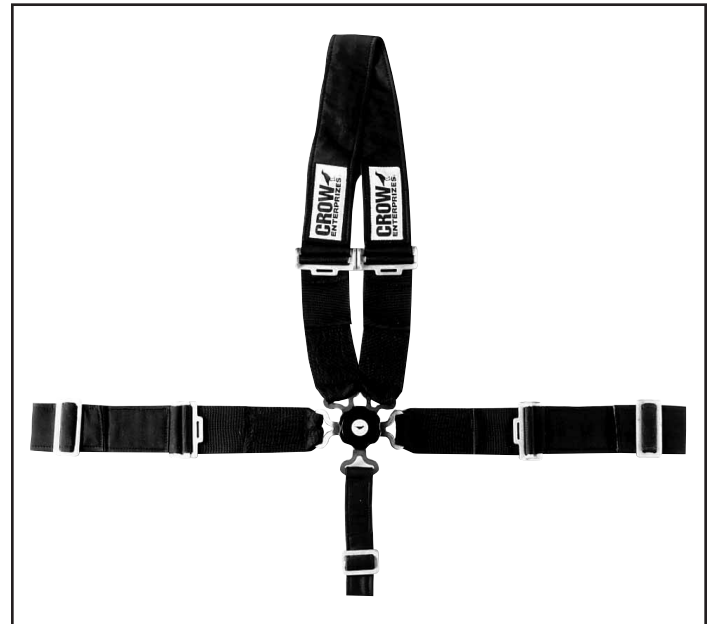

PART #	DESCRIPTION	PRICE
C11164	BLACK, WRAP AROUND	\$179.98

MOUNTING HARDWARE

Floor mount snap with eye bolt. One each per set.



PART #	DESCRIPTION	PRICE
C11546	MOUNTING HARDWARE	\$6.46

TENSION SPRINGS

Provides additional adjuster tension to 3" side belts or harness. Sold in set of four.



PART #	DESCRIPTION	PRICE
C11550	TENSION SPRINGS	\$10.00

BUGGY RESTRAINTS

Designed for offroad and buggy applications, not for competition use. These 3-way restraints feature a Y harness that is sewn in the seat belt. Standard latch and link mechanism with pull down adjustment.



3" x 3" SYSTEM		
PART #	DESCRIPTION	PRICE
C20142	RED, BOLT IN 3" X 3" SYSTEM	\$72.95
C20143	BLUE, BOLT IN 3" X 3" SYSTEM	\$72.95
C20144	BLACK, BOLT IN 3" X 3" SYSTEM	\$72.95
C20147	GRAY, BOLT IN 3" X 3" SYSTEM	\$72.95

3" x 2" SYSTEM		
PART #	DESCRIPTION	PRICE
C11202	RED, BOLT IN 3" X 2" SYSTEM	\$69.95
C11203	BLUE, BOLT IN 3" X 2" SYSTEM	\$69.95
C11204	BLACK, BOLT IN 3" X 2" SYSTEM	\$69.95
C11207	GRAY, BOLT IN 3" X 2" SYSTEM	\$69.95

HARNESS PADS

Constructed of flame retardant material. Slips over 3" wide belts providing extra comfort. Sold in pairs.



PART #	DESCRIPTION	PRICE
C11562	RED PADS	\$24.95
C11563	BLUE PADS	\$24.95
C11564	BLACK PADS	\$24.95

ARM RESTRAINTS

Helps keep hands and arms inside vehicle during a rollover. Fully adjustable, assembled with flame retardant material. Fits both latch and rotary style belts. Sold in pairs.



PART #	DESCRIPTION	PRICE
C11572	RED RESTRAINTS	\$24.95
C11573	BLUE RESTRAINTS	\$24.95
C11574	BLACK RESTRAINTS	\$24.95



tubing, plate & brackets

Chassis Shop stocks a huge inventory of tubing, plate, and brackets for all your fabrication needs including chromoly, mild steel, and aluminum. We stock all standard sizes and many hard to find sizes and shapes. All chromoly tubing is certified to meet aircraft quality

spec MIL T 6736 B. We can also custom bend tubing and cut to order. With over 90 in-stock varieties of pre-fabricated brackets, we can save you loads of time and money. Best of all, no minimums apply.

STREAMLINE CHROMOLY TUBING

PART #	MAJOR	MINOR	WALL THICKNESS	WEIGHT PER FOOT	1'-16' (PER FOOT)	1 FULL LENGTH (PER FOOT)	2 FULL LENGTHS (PER FOOT)	3-4 FULL LENGTHS (PER FOOT)	5+ FULL LENGTHS (PER FOOT)
41-1012-428-035	1.012"	.428"	.035"	.2687	\$12.48	\$9.98	\$9.36	\$8.74	\$8.11
41-1180-500-035	1.180"	.500"	.035"	.3140	\$14.04	\$11.23	\$10.53	\$9.83	\$9.13
41-1349-571-049	1.349"	.571"	.049"	.4977	\$14.64	\$11.71	\$10.98	\$10.25	\$9.52
41-1685-714-049	1.685"	.714"	.049"	.6285	\$18.36	\$14.69	\$13.77	\$12.85	\$11.93
41-1685-714-065	1.685"	.714"	.065"	.6914	\$22.56	\$18.05	\$16.92	\$15.79	\$14.66
41-2023-857-049	2.023"	.857"	.049"	.7593	\$21.96	\$17.57	\$16.47	\$15.37	\$14.27
41-2023-857-065	2.023"	.857"	.065"	.9962	\$25.44	\$20.35	\$19.08	\$17.81	\$16.54
41-2360-1-049	2.360"	1.0"	.049"	.8902	\$26.88	\$21.50	\$20.16	\$18.82	\$17.47
41-2360-1-058	2.360"	1.0"	.058"	1.170	\$29.40	\$23.52	\$22.05	\$20.58	\$19.11
41-2697-1143-049	2.360"	1.143"	.049"	1.021	\$31.20	\$24.96	\$23.40	\$21.84	\$20.28
41-3372-1429-049	3.372"	1.429"	.049"	1.283	\$39.00	\$31.20	\$29.25	\$27.30	\$25.35

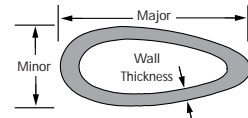

See note on page 77 regarding lengths and shipping.

SQUARE & RECTANGULAR CHROMOLY TUBING

SQUARE

PART #	SIZE	WALL THICKNESS	WEIGHT PER FOOT	1'-16' (PER FOOT)	1 FULL LENGTH (PER FOOT)	2 FULL LENGTHS (PER FOOT)	3-4 FULL LENGTHS (PER FOOT)	5+ FULL LENGTHS (PER FOOT)
41-34-34-058	3/4" X 3/4"	.058"	0.5454	\$6.48	\$5.18	\$4.86	\$4.54	\$4.21
41-1-1-065	1" X 1"	.065"	0.8265	\$6.96	\$5.57	\$5.22	\$4.87	\$4.52

RECTANGULAR

PART #	SIZE	WALL THICKNESS	WEIGHT PER FOOT	1'-16' (PER FOOT)	1 FULL LENGTH (PER FOOT)	2 FULL LENGTHS (PER FOOT)	3-4 FULL LENGTHS (PER FOOT)	5+ FULL LENGTHS (PER FOOT)
41-112-1-065	1-1/2" X 1"	.065"	1.0480	\$10.32	\$8.26	\$7.74	\$7.22	\$6.71
41-134-1-065	1-3/4" X 1"	.065"	1.1580	\$10.92	\$8.74	\$8.19	\$7.64	\$7.10
41-2-1-065	2" X 1"	.065"	1.2680	\$11.52	\$9.22	\$8.64	\$8.06	\$7.49

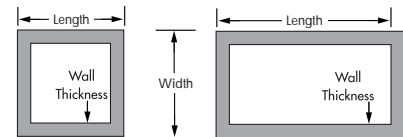

See note on page 77 regarding lengths and shipping.

ROUND TUBING

We offer a large, in stock selection of Threadable, Mild Steel, and Aluminum Round Tubing. Use chart at right to determine O.D. and I.D. size requirements.

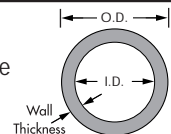

THREADABLE (1020-1026 MILD STEEL)

PART #	OUTSIDE DIAMETER	WALL THICKNESS	TAP SIZE	1'-16' (PER FOOT)	1 FULL LENGTH (PER FOOT)	2 FULL LENGTHS (PER FOOT)	3-4 FULL LENGTHS (PER FOOT)	5+ FULL LENGTHS (PER FOOT)
10-34-156	3/4"	.156"	1/2-20 NF*	\$5.05	\$4.04	\$3.79	\$3.54	\$3.28
10-78-156	7/8"	.156"	5/8-18 NF**	\$5.65	\$4.52	\$4.24	\$3.96	\$3.67
10-1-156	1"	.156"	3/4-16 NF	\$6.00	\$4.80	\$4.50	\$4.20	\$3.90

* Requires Pilot Drilling to 29/64"
 ** Requires Pilot Drilling to 37/64"

See note on page 77 regarding lengths and shipping.



MILD STEEL (1010-WELDED SEAM)

PART #	OUTSIDE DIAMETER	WALL THICKNESS	INSIDE DIAMETER	WEIGHT PER FOOT	1'-16' (PER FOOT)	1 FULL LENGTH (PER FOOT)	2 FULL LENGTHS (PER FOOT)	3-4 FULL LENGTHS (PER FOOT)	5+ FULL LENGTHS (PER FOOT)
10-1-065	1"	.065"	.870"	0.6491	\$2.40	\$1.92	\$1.80	\$1.68	\$1.56
10-114-083	1-1/4"	.083"	1.084"	1.034	\$1.20	\$0.96	\$0.90	\$0.84	\$0.78
10-112-095	1-1/2"	.095"	1.310"	1.426	\$1.92	\$1.54	\$1.44	\$1.34	\$1.25
10-158-134*	1-5/8"	.134"	1.357"	2.134	\$6.48	\$5.18	\$4.86	\$4.54	\$4.21

* This Material is 1020-1026 DOM

See note on page 77 regarding lengths and shipping.



ALUMINUM (6061-T6)

PART #	OUTSIDE DIAMETER	WALL THICKNESS	INSIDE DIAMETER	WEIGHT PER FOOT	1'-11' (PER FOOT)	1 FULL LENGTH (PER FOOT)	2 FULL LENGTHS (PER FOOT)	3-4 FULL LENGTHS (PER FOOT)	5+ FULL LENGTHS (PER FOOT)
60-38-058	3/8"	.058"	.259"	0.0694	\$1.32	\$1.06	\$0.99	\$0.92	\$0.86
60-12-058	1/2"	.058"	.384"	0.0962	\$1.80	\$1.44	\$1.35	\$1.26	\$1.17
60-34-058	3/4"	.058"	.643"	0.1506	\$2.40	\$1.92	\$1.80	\$1.68	\$1.56
60-78-065	7/8"	.065"	.745"	0.1979	\$2.64	\$2.11	\$1.98	\$1.85	\$1.72
60-1-065	1"	.065"	.870"	0.2295	\$2.88	\$2.30	\$2.16	\$2.02	\$1.87
60-1-083	1"	.083"	.834"	0.2866	\$3.36	\$2.69	\$2.52	\$2.35	\$2.18
60-2-065	2"	.065"	1.870"	0.4743	\$6.00	\$4.80	\$4.50	\$4.20	\$3.90
60-212-065	2-1/2"	.065"	2.370"	0.5196	\$7.92	\$6.34	\$5.94	\$5.54	\$5.15

Standard full length is 12', may be cut to order.

tubing

ROUND CHROMOLY TUBING

In addition to our specialty shapes, we offer a large selection of premium quality round chromoly tubing. The round chromoly is 4130 condition N and built to MIL T 6736 B specs. We purchase this material in large quantities and pass the savings on to you. Our large in stock inventory is priced right for small orders with additional discounts on full lengths; quantity discounts as listed. See page 77 for information on lengths and shipping.

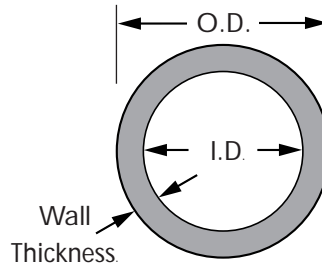

PART #	OUTSIDE DIAMETER	WALL THICKNESS	INSIDE DIAMETER	WEIGHT PER FOOT	1'-16' (PER FOOT)	1 FULL LENGTH (PER FOOT)	2 FULL LENGTHS (PER FOOT)	3-4 FULL LENGTHS (PER FOOT)	5+ FULL LENGTHS (PER FOOT)
41-516-035	5/16"	.035"	.243"	0.1039	\$2.00	\$1.60	\$1.50	\$1.40	\$1.30
41-38-035	3/8"	.035"	.305"	0.1271	\$1.90	\$1.52	\$1.43	\$1.33	\$1.24
41-38-049	3/8"	.049"	.277"	0.1706	\$1.80	\$1.44	\$1.35	\$1.26	\$1.17
41-38-058	3/8"	.058"	.259"	0.1964	\$2.00	\$1.60	\$1.50	\$1.40	\$1.30
41-12-035	1/2"	.035"	.430"	0.1738	\$2.00	\$1.60	\$1.50	\$1.40	\$1.30
41-12-049	1/2"	.049"	.402"	0.2360	\$2.10	\$1.68	\$1.58	\$1.47	\$1.37
41-12-058	1/2"	.058"	.384"	0.2738	\$1.90	\$1.52	\$1.43	\$1.33	\$1.24
41-12-065	1/2"	.065"	.370"	0.3020	\$2.64	\$2.11	\$1.98	\$1.85	\$1.72
41-12-083	1/2"	.083"	.334"	0.3696	\$3.12	\$2.50	\$2.34	\$2.18	\$2.03
41-12-120	1/2"	.120"	.260"	0.4870	\$3.84	\$3.07	\$2.88	\$2.69	\$2.50
41-58-035	5/8"	.035"	.555"	0.2205	\$2.04	\$1.63	\$1.53	\$1.43	\$1.33
41-58-049	5/8"	.049"	.527"	0.3014	\$2.16	\$1.73	\$1.62	\$1.51	\$1.40
41-58-058	5/8"	.058"	.509"	0.3512	\$2.16	\$1.73	\$1.52	\$1.51	\$1.41
41-58-065	5/8"	.065"	.495"	0.3888	\$2.28	\$1.82	\$1.71	\$1.60	\$1.48
41-58-083	5/8"	.083"	.459"	0.4805	\$3.12	\$2.50	\$2.34	\$2.18	\$2.03
41-58-120	5/8"	.120"	.385"	0.6472	\$3.84	\$3.07	\$2.88	\$2.69	\$2.50
41-34-035	3/4"	.035"	.680"	0.2673	\$2.28	\$1.82	\$1.71	\$1.60	\$1.48
41-34-049	3/4"	.049"	.652"	0.3668	\$2.00	\$1.60	\$1.50	\$1.40	\$1.30
41-34-058	3/4"	.058"	.634"	0.4287	\$2.16	\$1.73	\$1.62	\$1.51	\$1.41
41-34-065	3/4"	.065"	.620"	0.4755	\$2.00	\$1.60	\$1.50	\$1.40	\$1.30
41-34-083	3/4"	.083"	.584"	0.5913	\$3.36	\$2.69	\$2.52	\$2.35	\$2.18
41-34-120	3/4"	.120"	.510"	0.8074	\$3.96	\$3.17	\$2.97	\$2.77	\$2.57
41-78-035	7/8"	.035"	.805"	0.3140	\$2.52	\$2.02	\$1.89	\$1.76	\$1.64
41-78-049	7/8"	.049"	.777"	0.4323	\$2.10	\$1.68	\$1.58	\$1.47	\$1.37
41-78-058	7/8"	.058"	.759"	0.5061	\$2.28	\$1.82	\$1.71	\$1.60	\$1.48
41-78-065	7/8"	.065"	.745"	0.5623	\$2.76	\$2.21	\$2.07	\$1.93	\$1.80
41-78-083	7/8"	.083"	.709"	0.7021	\$3.48	\$2.78	\$2.61	\$2.44	\$2.26
41-78-120	7/8"	.120"	.635"	0.9676	\$4.68	\$3.74	\$3.51	\$3.28	\$3.04
41-1-035	1"	.035"	.930"	0.3607	\$2.52	\$2.02	\$1.89	\$1.76	\$1.64
41-1-049	1"	.049"	.902"	0.4977	\$2.40	\$1.92	\$1.80	\$1.68	\$1.56
41-1-058	1"	.058"	.884"	0.5835	\$2.40	\$1.92	\$1.80	\$1.68	\$1.56
41-1-065	1"	.065"	.870"	0.6491	\$2.60	\$2.08	\$1.95	\$1.82	\$1.69
41-1-083	1"	.083"	.834"	0.8129	\$3.60	\$2.88	\$2.70	\$2.52	\$2.34
41-1-095	1"	.095"	.810"	0.9182	\$3.96	\$3.17	\$2.97	\$2.77	\$2.57
41-1-120	1"	.120"	.760"	1.1280	\$4.80	\$3.84	\$3.60	\$3.36	\$3.12
41-118-049	1-1/8"	.049"	1.027"	0.5631	\$3.24	\$2.59	\$2.43	\$2.27	\$2.11
41-118-058	1-1/8"	.058"	1.009"	0.6609	\$2.60	\$2.08	\$1.95	\$1.82	\$1.69
41-118-065	1-1/8"	.065"	.995"	0.7359	\$2.88	\$2.30	\$2.16	\$2.02	\$1.87
41-118-083	1-1/8"	.083"	.959"	0.9237	\$3.36	\$2.69	\$2.52	\$2.35	\$2.18
41-118-095	1-1/8"	.095"	.935"	1.0450	\$4.80	\$3.84	\$3.60	\$3.36	\$3.12
41-118-120	1-1/8"	.120"	.885"	1.2880	\$5.64	\$4.51	\$4.23	\$3.95	\$3.67

ROUND CHROMOLY TUBING (CONTINUED)

PART #	OUTSIDE DIAMETER	WALL THICKNESS	INSIDE DIAMETER	WEIGHT PER FOOT	1'-16' (PER FOOT)	1 FULL LENGTH (PER FOOT)	2 FULL LENGTHS (PER FOOT)	3-4 FULL LENGTHS (PER FOOT)	5+ FULL LENGTHS (PER FOOT)
41-114-049	1-1/4"	.049"	1.152"	0.6285	\$3.48	\$2.78	\$2.61	\$2.44	\$2.26
41-114-058	1-1/4"	.058"	1.134"	0.7384	\$2.95	\$2.36	\$2.21	\$2.07	\$1.92
41-114-065	1-1/4"	.065"	1.120"	0.8226	\$3.10	\$2.48	\$2.33	\$2.17	\$2.02
41-114-083	1-1/4"	.083"	1.084"	1.0340	\$3.60	\$2.88	\$2.70	\$2.52	\$2.34
41-114-095	1-1/4"	.095"	1.060"	1.1720	\$3.96	\$3.17	\$2.97	\$2.77	\$2.57
41-114-120	1-1/4"	.120"	1.010"	1.4480	\$5.16	\$4.13	\$3.87	\$3.61	\$3.35
41-138-049	1-3/8"	.049"	1.277"	0.6939	\$3.96	\$3.17	\$2.97	\$2.77	\$2.57
41-138-058	1-3/8"	.058"	1.259"	0.8158	\$3.36	\$2.69	\$2.52	\$2.35	\$2.18
41-138-065	1-3/8"	.065"	1.245"	0.9094	\$3.60	\$2.88	\$2.70	\$2.52	\$2.34
41-138-083	1-3/8"	.083"	1.209"	1.1450	\$4.80	\$3.84	\$3.60	\$3.36	\$3.12
41-138-095	1-3/8"	.095"	1.185"	1.2990	\$4.90	\$3.92	\$3.68	\$3.43	\$3.19
41-138-120	1-3/8"	.120"	1.135"	1.6080	\$6.72	\$5.38	\$5.04	\$4.70	\$4.37
41-112-049	1-1/2"	.049"	1.402"	0.7593	\$4.68	\$3.74	\$3.51	\$3.28	\$3.04
41-112-058	1-1/2"	.058"	1.384"	0.8932	\$3.60	\$2.88	\$2.70	\$2.52	\$2.34
41-112-065	1-1/2"	.065"	1.370"	0.9962	\$3.40	\$2.72	\$2.55	\$2.38	\$2.21
41-112-083	1-1/2"	.083"	1.334"	1.2560	\$4.92	\$3.94	\$3.69	\$3.44	\$3.20
41-112-095	1-1/2"	.095"	1.310"	1.4260	\$5.16	\$4.13	\$3.87	\$3.61	\$3.35
41-112-120	1-1/2"	.120"	1.260"	1.7690	\$6.36	\$5.09	\$4.77	\$4.45	\$4.13
41-158-065	1-5/8"	.065"	1.495"	1.0830	\$4.56	\$3.65	\$3.42	\$3.19	\$2.96
41-158-083	1-5/8"	.083"	1.459"	1.3670	\$4.32	\$3.46	\$3.24	\$3.02	\$2.81
41-158-120	1-5/8"	.120"	1.385"	1.9290	\$7.20	\$5.76	\$5.40	\$5.04	\$4.68
41-134-083	1-3/4"	.083"	1.584"	1.4780	\$6.36	\$5.09	\$4.77	\$4.45	\$4.13
41-134-120	1-3/4"	.120"	1.510"	2.0890	\$7.44	\$5.95	\$5.58	\$5.21	\$4.84

DROP BOX

An assortment of our chromoly "drop" pieces of tubing. Each 10# box may contain an assortment of round, square, rectangle or streamline tubing. The drop box is very useful for a variety of projects.



PART #	DESCRIPTION	PRICE
C63-001	TUBING DROP BOX	\$19.95

NOTE ON LENGTHS AND SHIPPING

Tubing is manufactured in random lengths ranging from 17' to 24'. If you can use lengths 8' long or less, UPS is the fastest and most economical way to ship. For best pricing, specify "full length cut to 8' plus drops". We will also cut to lesser lengths within reason.

Full lengths must be taken to receive full length pricing.

For orders with pieces over 8' long, truck shipment will be required and you will receive full random lengths.

All orders are carefully packaged for safe shipment.

We work hard to find the safest transportation and the lowest possible cost for all truck orders.



TECH TIP

TELESCOPING TUBING? For best fit when telescoping tubing, select .058" wall material and slide over 1/8" smaller O.D. tubing.

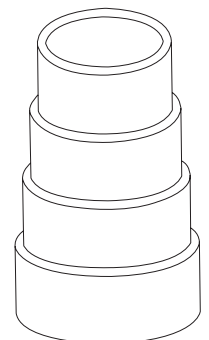

ROUND CHROMOLY BAR

This material is condition N, 4130 chromoly bar. Priced by the foot. A full length measures 12' long. May be cut to order.

PART #	DESCRIPTION	PRICE (PER FOOT)
41B-58	5/8" DIA CHROMOLY BAR	\$2.52
41B-34	3/4" DIA CHROMOLY BAR	\$2.88
41B-78	7/8" DIA CHROMOLY BAR	\$4.20
41B-1	1" DIA CHROMOLY BAR	\$6.00
41B-118	1-1/8" DIA CHROMOLY BAR	\$6.72
41B-114	1-1/4" DIA CHROMOLY BAR	\$8.28



CHROMOLY & ALUMINUM PLATE

Chromoly plate is aircraft 4130 condition N, perfect for fabbing those custom brackets for your project. Aluminum plate is 6061-T6, ideal for fabricating mounting plates and lightweight brackets. **Note: Chromoly plate is also available in custom cut size, priced by the square foot with an additional minimum \$10.00 cut charge. All edges are plasma cut.**

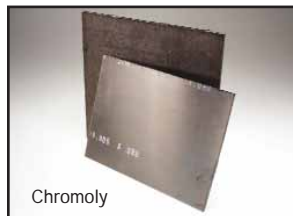

ALUMINUM				
PART #	SIZE	THICKNESS	WEIGHT	PRICE
6061-18	12" X 12"	.125"	1.76 #/ SQ FT	\$12.39
6061-316	12" X 12"	.190"	2.68 #/ SQ FT	\$18.87
6061-14	12" X 12"	.250"	3.52 #/ SQ FT	\$24.79
6061-38	12" X 12"	.375"	5.36 #/ SQ FT	\$53.87
C52-302	24" X 24"	.250"	3.52 #/ SQ FT	\$79.95
C52-303	24" X 24"	.375"	5.36 #/ SQ FT	\$119.95

CHROMOLY				
PART #	SIZE	THICKNESS	WEIGHT	PRICE
4130-116	9" X 12"	.063"	2.57 #/ SQ FT	\$11.95
4130-332	9" X 12"	.090"	3.67 #/ SQ FT	\$15.00
4130-18	9" X 12"	.125"	5.10 #/ SQ FT	\$21.00
4130-316	12" X 12"	.190"	7.75 #/ SQ FT	\$45.60
4130-14	12" X 12"	.250"	10.21 #/ SQ FT	\$51.68

CUSTOM TUBE BENDING

We offer custom tube bending of our material. Our minimum basic single bend cost is \$20.00 per bend plus material. Complex pieces requiring additional layout time will be charged accordingly. Our sales people can provide assistance and quoting. We can custom bend tubing from 3/8" to 1-5/8" dia. Mail or fax us a drawing using the information listed on the chart below as your guide on our available tooling. Allow 5-10 working days for scheduling.

TUBE DIA	BEND RADIUS	MIN. WALL THICKNESS	MIN. LEG LENGTH	MAX. DEGREE OF BEND
3/8"	15/16"	0.035	1-1/2"	180
1/2"	1-1/2"	0.035	2"	180
3/4"	4"	0.049	3"	120
7/8"	4"	0.058	3"	120
1"	5"	0.058	4-3/4"	180
1-1/8"	5-1/2"	0.058	4-7/8"	180
1-1/4"	6"	0.058	5"	180
1-3/8"	6"	0.058	5"	180
1-1/2"	6"	0.065	7"	180
1-5/8"	7"	0.065	7-1/2"	180

WELDING FILLER ROD

This #65 triple deoxidized filler rod is the choice of many leading chassis builders for chromoly and mild steel tig welding. Aluminum filler rod is available in two different materials.



Note: All welding should be performed by a trained and experienced welder.

#65 FILLER ROD			
PART #	SIZE	# PCS/ LB	PRICE
C73-002	1/16" X 36"	34	\$4.49
C73-004	3/32" X 36"	14	\$4.49

ALUMINUM FILLER ROD				
PART #	SIZE	APPLICATION	# PCS/ LB	PRICE
C73-006	1/16" X 36"	3003 ALUM ALLOYS	75	\$10.49
C73-007	3/32" X 36"	3003 ALUM ALLOYS	40	\$10.49
C73-008	1/16" X 36"	5052, 6061 ALUM ALLOYS, 6061 TO 3003, MOST CASTINGS	75	\$10.49
C73-009	3/32" X 36"	5052, 6061 ALUM ALLOYS, 6061 TO 3003, MOST CASTINGS	40	\$10.49

DRAGSTER ROLL BAR PAD- SFI CERTIFIED 45.1

Provides clean and sanitary compliance with NHRA roll bar pad requirement. Includes velcro self-adhesive installation tape. Fits all standard dragster type cages. Available in a 3 ft long length or as a kit. Kit includes two 18" pieces, two 13" pieces, and one 4" piece.



PART #	DESCRIPTION	PRICE
C72-150	BLACK KIT	\$74.95
C72-156	3' BLACK PAD	\$35.00/EA



PRE-BENT CHROMOLY CAGES

If you're building a new car or updating your current race car, these affordable pre-bent chromoly pieces are perfect for the professional chassis builder and the do-it-yourselfer. You may choose from our standard cage kits or individual pieces, which will fit most installations. We also offer custom cage kits built to your specifications.



6-pt Cage

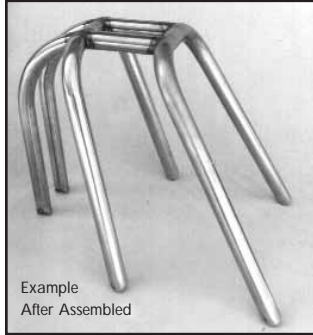

Example After Assembled



5-pt Cage

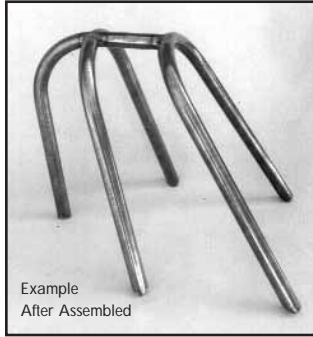

Example After Assembled

Note: 1-1/8" dia. cages are bent on a 5-1/2" radius, 1-1/2" dia. cages are bent on a 6" radius and 1-5/8" dia. cages are bent on a 7" radius. All kits include our standard pre-bent chromoly tubing.

PART #	DESCRIPTION	PRICE
C42-270	5-PT (1-1/2 X .065)	\$104.95
C42-271	5-PT (1-5/8 X .083)	\$120.95
C42-274	6-PT (1-1/8 X .058) JR DRAGSTER	\$94.95
C42-275	6-PT (1-1/2 X .065)	\$149.95
C42-276	6-PT (1-5/8 X .083)	\$169.95

CUSTOM CHROMOLY CAGE KITS

When a standard kit won't fit your application. We can custom bend cages to your specifications. Please allow extra production time.

PART #	DESCRIPTION	PRICE
C42-260	5-PT (1-1/2 X .065)	\$149.95
C42-261	5-PT (1-5/8 X .083)	\$165.95
C42-264	6-PT (1-1/8 X .058) JR DRAGSTER	\$149.95
C42-265	6-PT (1-1/2 X .065)	\$194.95
C42-266	6-PT (1-5/8 X .083)	\$214.95

PRE-BENT CHROMOLY TUBING



PART #	DESCRIPTION	DIMENSIONS	PRICE
C42-280	SHOULDER HOOP	1-3/8 X .058, 20-1/2" CENTERS X 72" LONG	\$94.95
C42-283	SHOULDER HOOP (JR DRAGSTER)	1-1/8 X .058, 17-1/2" CENTERS X 60" LONG	\$81.95
C42-286	SEAT FORM BARS (PR)	1-1/4 X .058	\$47.95
C42-288	SEAT FORM BARS (PR)	7/8 X .058 (JR DRAGSTER)	\$40.95
C42-290	5-PT FRONT HOOP	1-1/2 X .065 (SNG BEND), 26" TALL X 20" CENTERS	\$43.95
C42-294	5-PT FRONT HOOP	1-5/8 X .083 (SNG BEND), 26" TALL X 20" CENTERS	\$50.95
C42-297	6-PT FRONT HOOP (JR DRAGSTER)	1-1/8 X .058 (DBL BEND), 21" TALL X 17" CENTERS	\$41.95
C42-302	6-PT FRONT HOOP	1-1/2 X .065 (DBL BEND), 26" TALL X 20" CENTERS	\$54.95
C42-306	6-PT FRONT HOOP	1-5/8 X .083 (DBL BEND), 26" TALL X 20" CENTERS	\$61.95
C42-291	5-PT INTERMEDIATE HOOP	1-1/2 X .065 (SNG BEND), 22" TALL X 21" CENTERS	\$39.95
C42-295	5-PT INTERMEDIATE HOOP	1-5/8 X .083 (SNG BEND), 22" TALL X 21" CENTERS	\$46.95
C42-298	6-PT INTERMEDIATE HOOP (JR DRAGSTER)	1-1/8 X .058 (DBL BEND), 17" TALL X 18" CENTERS	\$39.95
C42-303	6-PT INTERMEDIATE HOOP	1-1/2 X .065 (DBL BEND), 22" TALL X 21" CENTERS	\$50.95
C42-307	6-PT INTERMEDIATE HOOP	1-5/8 X .083 (DBL BEND), 22" TALL X 21" CENTERS	\$56.95
C42-292	BACK BAR	1-1/2 X .065, 17" TALL X 15" DEEP X 80 DEGREE BEND	\$29.50
C42-296	BACK BAR	1-5/8 X .083, 17" TALL X 15" DEEP X 80 DEGREE BEND	\$32.50
C42-299	BACK BAR (JR DRAGSTER)	1-1/8 X .058, 16 TALL X 13" DEEP X 80 DEGREE BEND	\$23.95

PRE-BENT PACKAGES

Everything you need with just one part number for easy ordering. Assembled with our pre-bent chromoly tubing, listed above.

PART #	DESCRIPTION	PRICE
C42-320	6-PT 1-1/2 X .065 PRE-BENT CAGE KIT, 1-3/8 X .058 SHOULDER HOOP, 1-1/4 X .058 SEAT FORMERS	\$275.00
C42-323	6-PT 1-5/8 X .083 PRE-BENT CAGE KIT, 1-3/8 X .058 SHOULDER HOOP, 1-1/4 X .058 SEAT FORMERS	\$295.00
C42-326	6-PT 1-1/8 X .058 PRE-BENT CAGE KIT, 1-1/8 X .058 SHOULDER HOOP, 7/8 X .058 SEAT FORMERS	\$220.00

MANDREL PRE-BENT TUBING

These mandrel bent steel pieces make fabrication of your own custom header or intake system a simple task.

U-BEND

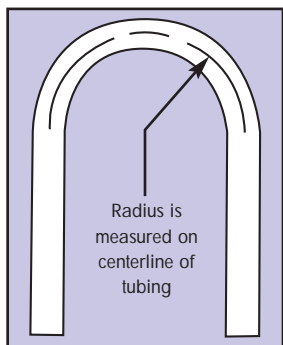

PART #	OUTSIDE DIA	RADIUS	THICKNESS	PRICE
C76-500	1-3/8"	2-1/2"	16 GAUGE	\$8.95
C76-502	1-1/2"	2-1/2"	16 GAUGE	\$9.50
C76-504	1-5/8"	2-1/2"	16 GAUGE	\$9.75
C76-506	1-5/8"	3"	16 GAUGE	\$9.75
C76-508	1-3/4"	2-1/2"	16 GAUGE	\$9.75
C76-510	1-7/8"	3"	18 GAUGE	\$10.25
C76-512	2"	3"	16 GAUGE	\$11.95
C76-513	2-1/8"	3"	16 GAUGE	\$14.95
C76-514	2-1/4"	4"	16 GAUGE	\$15.95
C76-516	2-1/4"	4-1/2"	16 GAUGE	\$15.95
C76-518	2-1/2"	4"	16 GAUGE	\$16.95
C76-520	3"	6"	16 GAUGE	\$22.50

COMBO BEND

The combination of a 90° bend and 180° bend, may be just what you need to build your project.

PART #	OUTSIDE DIA	RADIUS	THICKNESS	PRICE
C76-440	1-3/8"	2-1/2"	16 GAUGE	\$16.45
C76-442	1-1/2"	2-1/2"	16 GAUGE	\$16.45
C76-444	1-5/8"	2-1/2"	16 GAUGE	\$16.95
C76-446	1-3/4"	2-1/2"	16 GAUGE	\$16.95
C76-447	1-7/8"	3"	18 GAUGE	\$17.95



DONUT

Perfect for custom exhaust system or intake manifold fabrication where tight bends are required. May be cut to accommodate any degree of bend necessary, the inner seam requires finish welding after cutting.



MILD STEEL

PART #	OUTSIDE DIA	RADIUS	THICKNESS	PRICE
C76-560	1-1/2"	1-1/2"	16 GAUGE	\$23.25
C76-561	1-5/8"	1-5/8"	16 GAUGE	\$24.02
C76-562	1-3/4"	1-3/4"	16 GAUGE	\$24.80
C76-563	1-7/8"	1-7/8"	16 GAUGE	\$25.57
C76-564	2"	2"	16 GAUGE	\$26.35
C76-565	2-1/8"	2-1/8"	16 GAUGE	\$27.12
C76-566	2-1/4"	2-1/4"	16 GAUGE	\$27.90
C76-567	2-3/8"	2-3/8"	16 GAUGE	\$28.67
C76-568	2-1/2"	2-1/2"	16 GAUGE	\$29.45
C76-569	3"	3"	16 GAUGE	\$37.20
C76-570	3-1/2"	3-1/2"	16 GAUGE	\$40.30
C76-571	4"	4"	16 GAUGE	\$44.95
C76-572	4-1/2"	4-1/2"	16 GAUGE	\$62.00
C76-573	5"	5"	16 GAUGE	\$82.25

STAINLESS STEEL

PART #	OUTSIDE DIA	RADIUS	THICKNESS	PRICE
C76-560-SS	1-1/2"	1-1/2"	16 GAUGE	\$46.50
C73-561-SS	1-5/8"	1-5/8"	16 GAUGE	\$48.05
C76-562-SS	1-3/4"	1-3/4"	16 GAUGE	\$49.60
C76-563-SS	1-7/8"	1-7/8"	16 GAUGE	\$51.15
C76-564-SS	2"	2"	16 GAUGE	\$52.70
C76-565-SS	2-1/8"	2-1/8"	16 GAUGE	\$54.25
C76-566-SS	2-1/4"	2-1/4"	16 GAUGE	\$55.80
C76-567-SS	2-3/8"	2-3/8"	16 GAUGE	\$57.35
C76-568-SS	2-1/2"	2-1/2"	16 GAUGE	\$58.90
C76-569-SS	3"	3"	16 GAUGE	\$74.40
C76-570-SS	3-1/2"	3-1/2"	16 GAUGE	\$82.15
C76-571-SS	4"	4"	16 GAUGE	\$93.00



Ideal for super-tight areas

MILD STEEL BRACKETS

Our large selection of quality die stamped mild steel tabs will save you time and money! No more cutting or filing; we've got a tab for every need...and at an affordable price.

MILD STEEL FLAT TABS

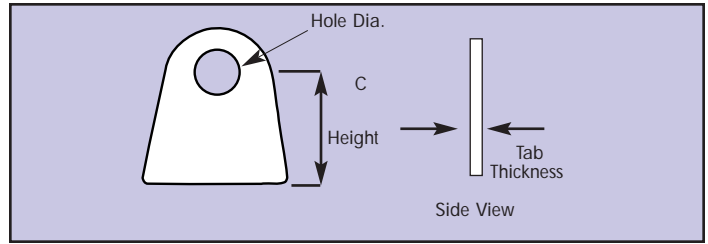
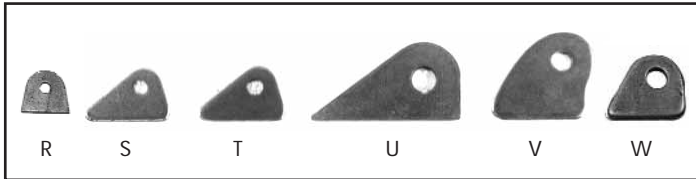
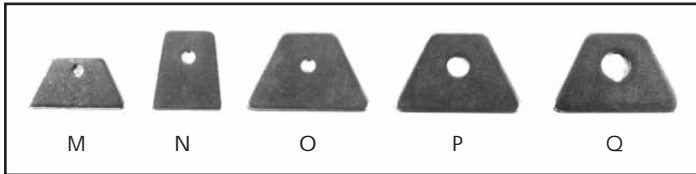
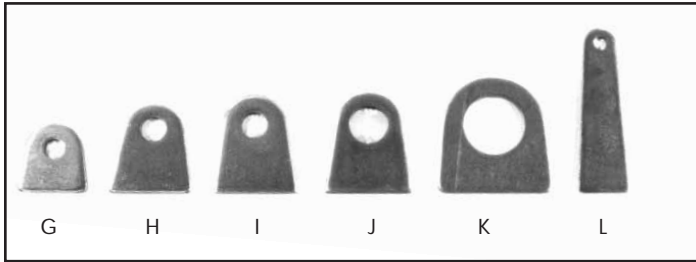
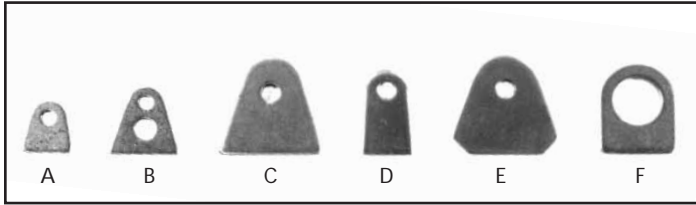

SOLD IN PACKS OF 10

REF	PART #	HOLE DIA.	THICKNESS	HEIGHT	DISCOUNT PRICE PER PACK		
					1-2	3-5	6+
A	C73-101-10	3/16"	1/16"	1/2"	\$6.00	\$5.10	\$4.38
B	C73-102-10	3/16"	1/16"	3/4"	\$6.20	\$5.27	\$4.53

SOLD IN PACKS OF 2

REF	PART #	HOLE DIA.	THICKNESS	HEIGHT	DISCOUNT PRICE PER PACK		
					1-12	13-24	25+
C	C73-095-2	1/4"	1/8"	7/8"	\$1.84	\$1.56	\$1.34
D	C73-096-2	1/4"	1/8"	15/16"	\$3.12	\$2.65	\$2.28
E	C73-103-2	1/4"	3/32"	15/16"	\$1.00	\$0.85	\$0.73
F	C73-104-2	5/8"	3/32"	3/4"	\$3.36	\$2.86	\$2.45
G	C73-115-2	3/8"	3/16"	7/8"	\$3.00	\$2.55	\$2.19
H	C73-185-2	1/2"	1/8"	1-5/16"	\$2.80	\$2.38	\$2.04
H	C73-116-2	1/2"	3/16"	1-5/16"	\$3.00	\$2.55	\$2.19
I	C73-117-2	1/2"	1/4"	1-3/8"	\$3.84	\$3.26	\$2.80
J	C73-187-2	3/4"	1/4"	1-3/8"	\$3.84	\$3.26	\$2.80
K	C73-105-2	1-3/16"	1/8"	1-3/8"	\$3.56	\$3.03	\$2.60
L	C73-106-2	1/4"	1/8"	3"	\$3.16	\$2.69	\$2.31
M	C73-107-2	3/16"	1/8"	3/4"	\$0.74	\$0.63	\$0.54
N	C73-108-2	1/4"	3/32"	1"	\$2.68	\$2.28	\$1.96
O	C73-109-2	1/4"	3/32"	7/8"	\$1.20	\$1.02	\$0.88
P	C73-110-2	3/8"	3/32"	7/8"	\$1.20	\$1.02	\$0.88
Q	C73-111-2	1/2"	3/16"	7/8"	\$1.04	\$0.88	\$0.76
Q	C73-112-2	1/2"	1/4"	7/8"	\$1.14	\$0.97	\$0.83
R	C73-131-2	1/4"	1/16"	11/16"	\$1.60	\$1.36	\$1.17
S	C73-098-2	1/4"	1/8"	11/16"	\$2.68	\$2.28	\$1.96
T	C73-099-2	5/16"	3/16"	11/16"	\$2.80	\$2.38	\$2.04
U	C73-113-2	1/2"	3/16"	1-3/16"	\$5.04	\$4.28	\$3.68
V	C73-114-2	3/8"	1/8"	1-3/16"	\$4.56	\$3.88	\$3.33
W	C73-132-2	1/2"	3/16"	1"	\$3.40	\$2.89	\$2.48

MILD STEEL RADIUS TABS

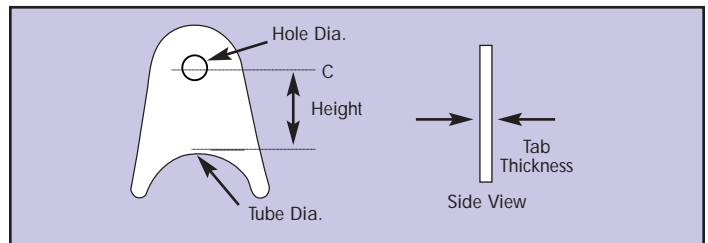
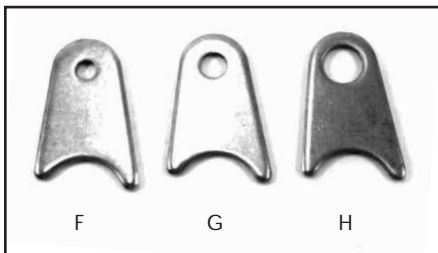
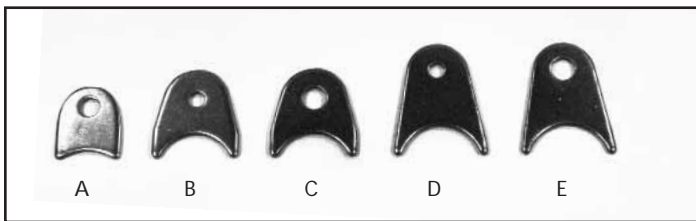

SOLD IN PACKS OF 2

REF	PART #	HOLE DIA.	THICKNESS	HEIGHT	TUBE DIA.	DISCOUNT PRICE PER PACK		
						1-12	13-24	25+
A	C73-128-2	5/16"	3/32"	3/4"	1-1/2"	\$2.60	\$2.21	\$1.90
B	C73-129-2	1/4"	1/8"	9/16"	1-1/4"	\$2.16	\$1.84	\$1.58
C	C73-130-2	3/8"	1/8"	9/16"	1-1/4"	\$2.16	\$1.84	\$1.58
D	C73-140-2	1/4"	1/8"	15/16"	1-1/4"	\$2.92	\$2.48	\$2.13
E	C73-150-2	3/8"	1/8"	15/16"	1-1/4"	\$3.58	\$3.04	\$2.61
F	C73-145-2	3/8"	3/16"	1-3/4"	1-5/8"	\$3.84	\$3.26	\$2.80
G	C73-151-2	1/2"	3/16"	1-3/4"	1-5/8"	\$3.84	\$3.26	\$2.80
H	C73-147-2	3/4"	3/16"	1-3/4"	1-5/8"	\$4.88	\$4.15	\$3.56

MILD STEEL HINGE BRACKETS

SOLD IN PACKS OF 4

PART #	HOLE DIA.	THICKNESS	HEIGHT	QTY. DISCOUNT		
				1-25	26-50	51+
C73-133	1/4"	3/32"	1-7/8"	\$5.90	\$5.02	\$4.52



TECH TIP

MILD STEEL can be successfully welded to chromoly using the proper filling rod (see pg. 78). Always select chromoly tabs for applications requiring ultimate strength.

MILD STEEL FLANGES

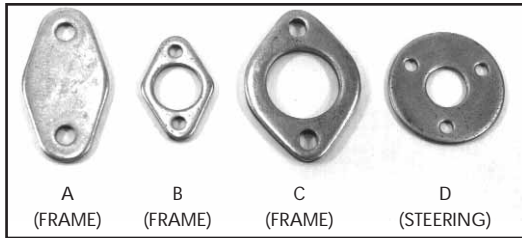

SOLD IN PACKS OF 2

REF	PART #	HOLE DIA.	THICKNESS	TUBE DIA.	DISCOUNT PRICE PER PACK		
					1-12	13-24	25+
A	C73-161-2	3/8"	1/4"	1-3/8"	\$4.64	\$3.94	\$3.39
B	C73-164-2	1/4"	3/16"	1"	\$4.04	\$3.43	\$2.95
C	C73-160-2	5/16"	1/4"	1-1/2"	\$3.32	\$2.82	\$2.42

SOLD INDIVIDUALLY

REF	PART #	HOLE DIA.	THICKNESS	TUBE DIA.	QUANTITY DISCOUNT		
					1-25	26-50	51+
D	C73-163	1/4"	1/8"	7/8"	\$1.90	\$1.62	\$1.39

MILD STEEL GUSSETS

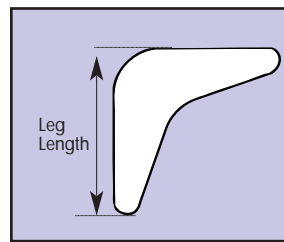
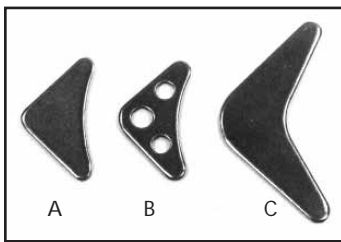

SOLD IN PACKS OF 4

REF.	PART #	THICKNESS	LEG LENGTH	DISCOUNT PRICE PER PACK		
				1-6	7-12	13+
A	C73-152-4	1/8"	1-7/8"	\$1.92	\$1.63	\$1.40
B	C73-153-4	1/8"	1-7/8"	\$1.60	\$1.36	\$1.17
C	C73-154-4	1/8"	3"	\$4.96	\$4.22	\$3.62

MILD STEEL PINTO RACK-N-PINION BRACKETS



SOLD IN PACKS OF 2

PART #	HOLD DIA.	THICKNESS	C-C LENGTH	DISCOUNTED PRICE PER PACK		
				1-25	26-50	51+
C73-172*	3/8"	3/16"	2-7/8"	\$11.48	\$9.76	\$8.78

* Fits 1-1/2" dia. tube

MILD STEEL SHOCK BRACKET

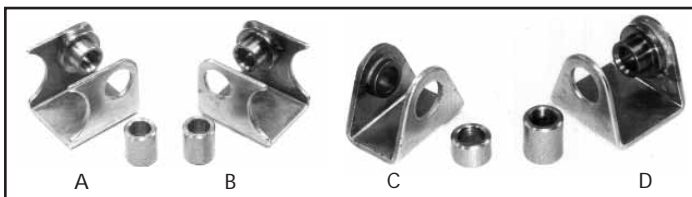

Bolt Not Included.



SOLD INDIVIDUALLY

REF	PART #	DIMENSIONS	QUANTITY DISCOUNT		
			1-25	26-50	51+
A	C73-155	1/2" BOLT- RADIUS MT (RIGHT), 1-1/2" TUBE DIA*	\$7.25	\$6.16	\$5.29
B	C73-156	1/2" BOLT- RADIUS MT (LEFT), 1-1/2" TUBE DIA*	\$7.25	\$6.16	\$5.29
C	C73-157	1/2" BOLT- 1-1/4" FLAT MT*	\$7.25	\$6.16	\$5.29
D	C73-158	1/2" BOLT- 1-7/8" FLAT MT*	\$7.25	\$6.16	\$5.29
E	C73-159	1/2" BOLT 2 PC RADIUS TAB*	\$7.25	\$6.16	\$5.29

* Includes Bushings

SOLD IN PACKS OF 2

PART #	DIMENSIONS	DISCOUNT PRICE PER PACK		
		1-12	13-24	25+
C73-165-2	BUSHING ONLY, 1/2" ID X 1/2" LONG	\$2.24	\$1.90	\$1.64
C73-169-2	BUSHING ONLY, 1/2" ID X 7/8" LONG	\$2.56	\$2.18	\$1.87

MILD STEEL BENT TABS

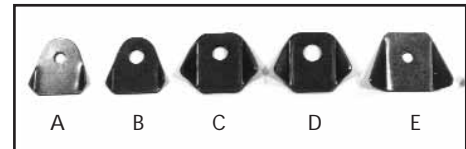

SOLD IN PACKS OF 2

REF	PART #	HOLE DIA.	THICKNESS	HEIGHT	DISCOUNT PRICE PER PACK		
					1-12	13-24	25+
A	C73-118-2	1/4"	3/32"	15/16"	\$1.68	\$1.43	\$1.23
B	C73-119-2	3/8"	3/32"	15/16"	\$2.16	\$1.84	\$1.58
C	C73-120-2	3/8"	1/8"	1"	\$2.00	\$1.70	\$1.46
D	C73-121-2	7/16"	1/8"	1"	\$2.16	\$1.84	\$1.58
E	C73-122-2	1/4"	3/32"	7/8"	\$2.16	\$1.84	\$1.58
E	C73-123-2	3/8"	3/32"	7/8"	\$2.16	\$1.84	\$1.58

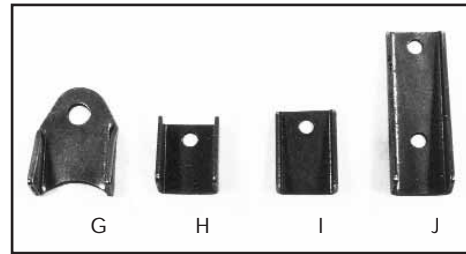

SOLD IN PACKS OF 2

REF	PART #	HOLE DIA.	THICKNESS	HEIGHT	DISCOUNT PRICE PER PACK		
					1-12	13-24	25+
G	C73-124-2*	3/8"	1/8"	1-1/4"	\$6.38	\$5.42	\$4.66
H	C73-125-2	1/4"	3/32"	1"	\$5.02	\$4.27	\$3.66
I	C73-126-2	1/4"	3/32"	1-1/4"	\$6.96	\$5.92	\$5.08
J	C73-127-2	1/4"	3/32"	1-3/4" C-C	\$5.98	\$5.08	\$4.37

* Fits 1-1/2" dia. tube

MILD STEEL CLEVIS LINK BRACKET



SOLD INDIVIDUALLY

REF	PART #	SIDE HOLES	MOUNT HOLE	QUANTITY DISCOUNT		
				1-25	26-50	51+
A	C73-175*	1/2" DIA.	1/2" DIA.	\$10.12	\$8.60	\$7.74
B	C73-176*	1/2" DIA.	5/8" DIA.	\$10.12	\$8.60	\$7.74

* Brackets are both 3/16" thick and 1" wide inside.

CHROMOLY BRACKETS

These high-strength chromoly chassis brackets take the hassle out of trying to cut & drill 4130 bracketry. Many popular styles to choose from.

CHROMOLY FLAT TABS

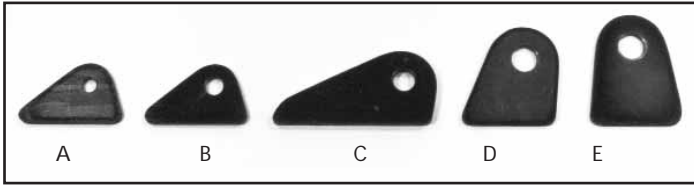

SOLD IN PACKS OF 2

DISCOUNT
PRICE PER PACK

REF.	PART #	HOLE DIA.	THICKNESS	HEIGHT	1-12	13-24	25+
A	C73-217-2	1/4"	1/8"	11/16"	\$6.98	\$6.28	\$5.93
B	C73-218-2	5/16"	1/8"	11/16"	\$6.98	\$6.28	\$5.93
B	C73-213-2	5/16"	3/16"	11/16"	\$6.98	\$6.28	\$5.93
D	C73-231-2	7/16"	1/8"	1-1/8"	\$6.98	\$6.28	\$5.93
C	C73-221-2	3/8"	3/16"	3/4"	\$6.98	\$6.28	\$5.93
E	C73-233-2	7/16"	1/8"	1-3/8"	\$6.98	\$6.28	\$5.93
E	C73-234-2	7/16"	3/16"	1-3/8"	\$6.98	\$6.28	\$5.93

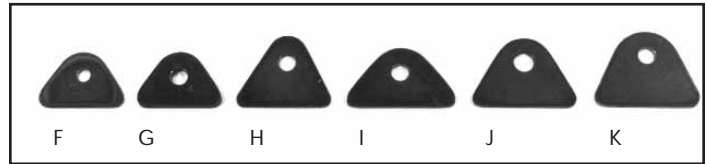
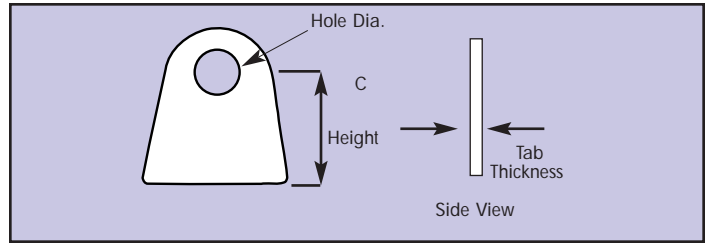

SOLD IN PACKS OF 2

DISCOUNT
PRICE PER PACK

REF.	PART #	HOLE DIA.	THICKNESS	HEIGHT	1-12	13-24	25+
F	C73-237-2	1/4"	1/8"	5/8"	\$6.98	\$6.28	\$5.93
G	C73-236-2	5/16"	3/16"	9/16"	\$6.98	\$6.28	\$5.93
H	C73-220-2	5/16"	.095"	7/8"	\$6.98	\$6.28	\$5.93
I	C73-239-2	5/16"	1/8"	5/8"	\$6.98	\$6.28	\$5.93
J	C73-241-2	3/8"	1/8"	7/8"	\$6.98	\$6.28	\$5.93
K	C73-242-2	5/16"	1/8"	1"	\$6.98	\$6.28	\$5.93

CHROMOLY RADIUS TABS

If necessary, you can modify (grind) the radius of these tabs to fit larger diameter tubing.

SOLD IN PACKS OF 2

DISCOUNT
PRICE PER PACK

REF.	PART #	HOLE DIA.	THICKNESS	HEIGHT	TUBE DIA.	1-12	13-24	25+
A	C73-229-2	1/4"	1/8"	9/16"	1-1/8"	\$6.98	\$6.28	\$5.93
B	C73-219-2	5/16"	1/8"	7/16"	1"	\$6.98	\$6.28	\$5.93
C	C73-208-2	1/4"	1/8"	1/2"	1-1/4"	\$3.70	\$3.33	\$3.15
D	C73-209-2	3/8"	1/8"	9/16"	1-1/4"	\$3.70	\$3.33	\$3.15
E	C73-210-2	3/8"	1/8"	7/8"	1-1/4"	\$4.40	\$3.96	\$3.74
F	C73-226-2	7/16"	1/8"	7/8"	1-3/8"	\$6.98	\$6.28	\$5.93
F	C73-227-2	7/16"	3/16"	7/8"	1-3/8"	\$6.98	\$6.28	\$5.93
G	C73-224-2	3/8"	1/8"	3/4"	1-3/8"	\$6.98	\$6.28	\$5.93

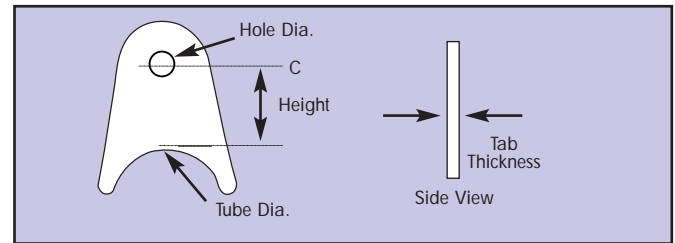
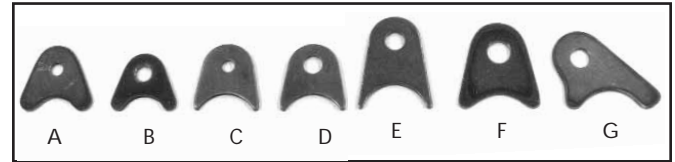

CHROMOLY MOUNT BRACKETS

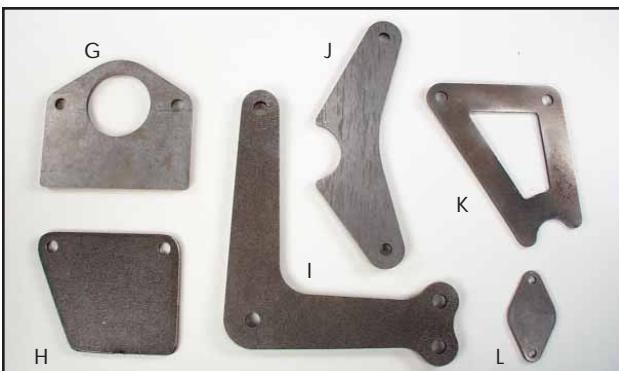
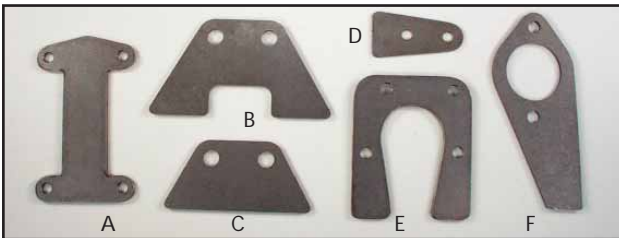

SOLD INDIVIDUALLY

QUANTITY DISCOUNT

REF.	PART #	APPLICATION	1-25	26-50	51+
A	C73-260	CNC STAGING BRAKE, 1/8" THICK	\$8.50	\$7.65	\$7.23
B	C73-266	STILLETTO RACK, 1/8" THICK	\$7.95	\$7.16	\$6.76
C	C73-267	STILLETTO RACK (SHORT), 1/8" THICK	\$7.95	\$7.16	\$6.76
D	C73-244	PROPORTIONING VALVE, 3/32" THICK	\$6.95	\$6.26	\$5.91
E	C73-265	HOLLEY ELEC FUEL PUMP, 1/8" THICK	\$8.50	\$7.65	\$7.23
F	C73-212	MASTER CYLINDER, 1/8" THICK	\$8.95	\$8.06	\$7.61
G	C73-261	WILWOOD TANDEM MASTER CYL, 3/16" THICK	\$10.45	\$9.41	\$8.88
H	C73-268	MASTER CYL SIDE MT, 3/16" THICK	\$10.45	\$9.41	\$8.88
I	C73-270	BELL CRANK STEERING ARM, 1/4" THICK	\$25.95	\$23.36	\$22.06
J	C73-271	FRONT AXLE BRACKET, 3/16" THICK, FITS 1-1/2" DIA TUBE	\$13.95	\$12.56	\$11.86

SOLD IN PACKS OF 2

DISCOUNT
PRICE PER PACK

REF.	PART #	APPLICATION	1-12	13-24	25+
K	C73-269	MASTER CYL SIDE MT, 1/8" THICK, FITS 1" DIA. TUBE	\$16.95	\$15.26	\$14.41
L	C73-214-2	CHROMOLY FLANGE, 3/16" HOLD DIA. 1/8" THICK, 1-15/16" HOLE SPACING	\$8.02	\$7.22	\$6.82

CHROMOLY BENT TABS

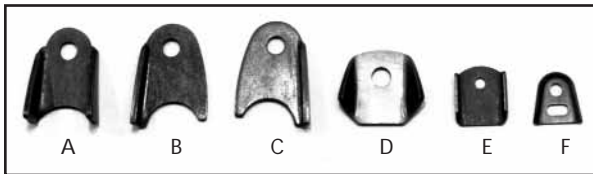

SOLD IN PACKS OF 2

REF	PART #	HOLE DIA	THICKNESS	HEIGHT	TUBE DIA	DISCOUNT PRICE PER PACK		
						1-12	13-24	25+
A	C73-201-2	3/8"	1/8"	1-3/16"	1-1/4"	\$13.36	\$12.02	\$11.36
B	C73-202-2	3/8"	1/8"	1-3/16"	1-1/4"	\$11.36	\$10.22	\$9.66
C	C73-203-2	3/8"	1/8"	1-3/16"	1-1/4"	\$11.36	\$10.22	\$9.66
D	C73-207-2	3/8"	1/8"	15/16"	NA	\$9.20	\$8.28	\$7.82
E	C73-211-2	3/16"	1/16"	7/8"	NA	\$6.84	\$6.16	\$5.81
F	C73-216-2	3/16"	1/16"	11/16"	NA	\$6.96	\$6.26	\$5.92

CHROMOLY ROD END CLEVIS

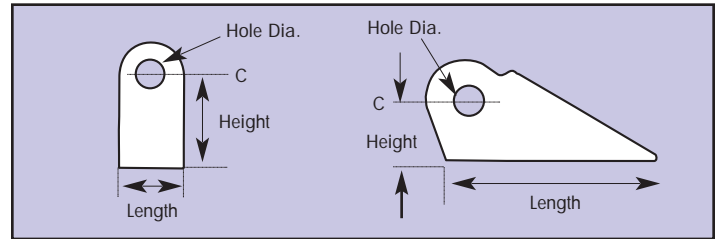
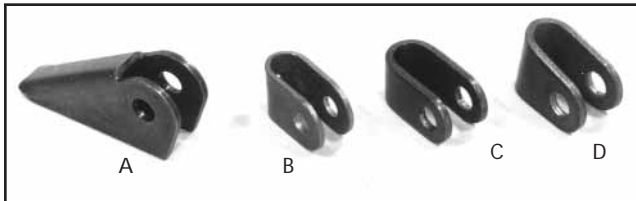

SOLD IN PACKS OF 2

REF	PART #	HOLE DIA	HEIGHT	LENGTH	INSIDE WIDTH	DISCOUNT PRICE PER PACK		
						1-12	13-24	25+
A	C73-204-2	3/8"	3/4"	2-3/4"	.500"	\$16.34	\$14.71	\$13.89
B	C73-222-2	5/16"	1"	7/8"	.437"	\$9.72	\$8.75	\$8.26
C	C73-205-2	3/8"	1-1/8"	3/4"	.500"	\$11.16	\$10.04	\$9.49
D	C73-206-2	3/8"	1-1/8"	1"	.500"	\$11.16	\$10.04	\$9.49

CHROMOLY FUNNY CAR BOX MOUNTS

Available in two versions, this weld on chromoly bracket is 1/8" thick and is notched to accept a 1-1/8" dia. tube.

SOLD INDIVIDUALLY

REF	PART #	DESCRIPTION	QUANTITY DISCOUNT		
			1-25	26-50	51+
A	C73-262	TOP MT.	\$16.95	\$15.26	\$14.41
B	C73-263	BOTTOM MT.	\$16.95	\$15.26	\$14.41

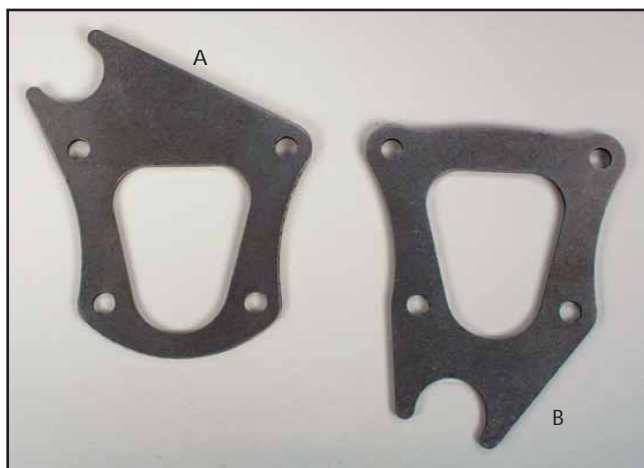

SLOT CLEVISES

The popular weld-in slot clevis will assist you in overcoming many fabrication obstacles. Available for tubing sizes 1/2" to 1-1/8" with appropriate holes and slots.

SOLD IN PACKS OF 2

DISCOUNT
PRICE PER PACK

FITS TUBE SIZE	SLOT	HOLE	PART #	1-4	5-9	10+
1/2" OD X .058"	1/8"	1/4"	C73-962-2	\$12.70	\$11.43	\$10.16
5/8" OD X .058"	1/8"	5/16"	C73-964-2	\$12.70	\$11.43	\$10.16
3/4" OD X .058"	3/16"	5/16"	C73-965-2	\$14.50	\$13.05	\$11.60
3/4" OD X .058"	3/16"	3/8"	C73-966-2	\$14.50	\$13.05	\$11.60
7/8" OD X .058"	3/16"	3/8"	C73-970-2	\$15.00	\$13.50	\$12.00
1" OD X .058"	3/16"	3/8"	C73-976-2	\$15.90	\$14.31	\$12.72
1" OD X .058"	1/4"	3/8"	C73-978-2	\$15.90	\$14.31	\$12.72
1-1/8" OD X .058"	1/4"	3/8"	C73-987-2	\$17.90	\$16.11	\$14.32

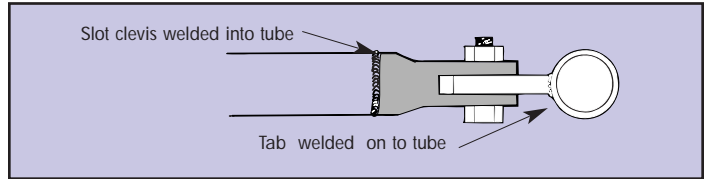

QUICK PINS

Use these quick pins for easy removal and installation of side bars, radiator mounts, crossmembers and wheelie bars.

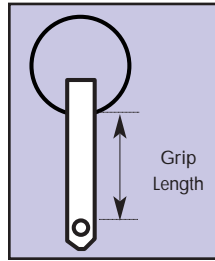

SOLD IN PACKS OF 2

DISCOUNT
PRICE PER PACK

PART #	DIA X GRIP	1-12	13-24	25+
C73-350-2	1/4 X .500"	\$5.98	\$5.08	\$4.37
C73-351-2	1/4 X .800"	\$5.98	\$5.08	\$4.37
C73-352-2	1/4 X 1"	\$5.98	\$5.08	\$4.37
C73-353-2	1/4 X 1.3"	\$5.98	\$5.08	\$4.37
C73-354-2	1/4 X 1.5"	\$5.98	\$5.08	\$4.37
C73-355-2	5/16 X .800"	\$5.98	\$5.08	\$4.37
C73-356-2	5/16 X 1"	\$5.98	\$5.08	\$4.37
C73-357-2	5/16 X 1.3"	\$7.18	\$6.46	\$5.74
C73-358-2	5/16 X 1.5"	\$7.18	\$6.46	\$5.74
C73-360-2	3/8 X .800"	\$7.58	\$6.82	\$6.06
C73-361-2	3/8 X 1"	\$7.58	\$6.82	\$6.06
C73-362-2	3/8 X 1.3"	\$7.58	\$6.82	\$6.06
C73-363-2	3/8 X 1.5"	\$7.58	\$6.82	\$6.06
C73-364-2	3/8 X 2"	\$7.58	\$6.82	\$6.06

EYE BOLT

5/16-24 RH, (1-1/2" Long Shank), 3/16" Thick, 1/4" Hole.



SOLD IN PACKS OF 2

SIZE	TAB THICKNESS	HOLE	PART #	PRICE
5/16-24 RH (1-1/2" Long Shank)	3/16"	1/4"	C73-417-2	\$29.90

THREADED SLOT CLEVIS

These threaded clevises, with their threaded shank, offer adjustability when needed. Several sizes to choose from.



SOLD IN PACKS OF 2

THREAD SIZE	SLOT	HOLE	MATERIAL	PART #	PRICE
10-32 RH	1/8	3/16	STAINLESS	C73-491-2	\$25.00
1/4-28 RH	1/8	3/16	STAINLESS	C73-493-2	\$25.00
3/8-24 RH	3/16	5/16	4130	C73-494-2	\$29.90
1/2-20 RH	1/4	3/8	4130	C73-496-2	\$29.90

brackets

tube adapters

Chassis Shop's wide selection of tube adapters are perfect for constructing linkage and suspension components for almost any application- we offer the most extensive selection available with over 100 size/thread combinations. Precision CNC machined from chromoly steel, our

super-light tolerances assure a snug fit in tubing for easy and precise welding. We stock both right-hand and left-hand threads. We mark left-hand threads with a special groove for easy identification. Our hex drives are available in select left-hand size for ease of adjustment.

HEX TUBE ADAPTERS

These weld-in threaded hex tube adapters are CNC machined from 4130 chromoly to precision tolerances. Ideal for quick and easy adjustment of linkage rods built with the combination of right hand and left hand threads.



SOLD IN PACKS OF 2

FITS TUBE SIZE	THREAD SIZE	LEFT HAND	DISCOUNT PRICE PER PACK			
			1-12	13-24	25-124	125+
3/4" OD X .058"	3/8-24	C73-837-H2	\$11.90	\$8.21	\$7.80	\$7.02
7/8" OD X .058"	3/8-24	C73-859-H2	\$13.00	\$8.97	\$8.52	\$7.67
7/8" OD X .058"	7/16-20	C73-861-H2	\$13.00	\$8.97	\$8.52	\$7.67
7/8" OD X .058"	1/2-20	C73-863-H2	\$13.00	\$8.97	\$8.52	\$7.67
1" OD X .058"	1/2-20	C73-889-H2	\$13.90	\$9.59	\$9.11	\$8.20
1-1/4" OD X .095"	3/4-16	C73-943-H2	\$15.90	\$10.97	\$10.42	\$9.38
1-1/4" OD X .120"	3/4-16	C73-947-H2	\$15.90	\$10.97	\$10.42	\$9.38
1-3/8" OD X .095"	3/4-16	C73-951-H2	\$15.90	\$10.97	\$10.42	\$9.38

STREAMLINE TUBE ADAPTERS

These weld-in threaded streamline tube adapters are CNC machined from 4130 chromoly to precision tolerances. You will appreciate the time these will save you when fabricating with streamline tubing.



SOLD INDIVIDUALLY

FITS TUBE SIZE	THREAD SIZE	RIGHT HAND	PRICE
1.349" X .571" X .049"	3/8-24	C78-024	\$24.95
1.685" X .714" X .065"	7/16-20	C78-032	\$29.95
2.023" X .857" X .065"	1/2-20	C78-040	\$29.95
2.360" X 1" X .058"	5/8-18	C78-048	\$29.95
2.697" X 1.143" X .049"	3/4-16	C78-052	\$34.95

TECH
TIP

STREAMLINE TUBING with its unique shape, is desirable for applications when reducing wind drag is beneficial. This shape, by its design, is stronger in tension than in compression. The maximum load capacity requirement of your application should be considered when selecting this or any other material.

ROUND TUBE ADAPTERS

Perfect for construction of linkage & suspension components. Weld-in 4130 threaded tube adapters. CNC machined chromoly, to precision tolerances with a jewelry quality finish. Right or left hand thread available.



Left hand tube adapters are marked with grooves for easy identification during assembly. Hex option also available on select sizes (see Pg. 87).



SOLD IN PACKS OF 2

FITS TUBE SIZE	THREAD SIZE	LEFT HAND	RIGHT HAND	DISCOUNT PRICE PER PACK			
				1-12	13-24	25-124	125+
5/16" OD	10-32	C73-801-2	C73-800-2	\$9.00	\$6.21	\$5.90	\$5.31
3/8" OD X .058"	10-32	C73-807-2	C73-806-2	\$9.00	\$6.21	\$5.90	\$5.31
1/2" OD X .058"	1/4-28	C73-813-2	C73-812-2	\$9.00	\$6.21	\$5.90	\$5.31
5/8" OD X .058"	5/16-24	C73-819-2	C73-818-2	\$9.00	\$6.21	\$5.90	\$5.31
5/8" OD X .058"	3/8-24	C73-821-2	C73-820-2	\$9.00	\$6.21	\$5.90	\$5.31
3/4" OD X .058"	5/16-24	C73-835-2	C73-834-2	\$9.40	\$6.49	\$6.17	\$5.55
3/4" OD X .058"	3/8-24	C73-837-2	C73-836-2	\$9.40	\$6.49	\$6.17	\$5.55
3/4" OD X .058"	7/16-20	C73-839-2	C73-838-2	\$9.40	\$6.49	\$6.17	\$5.55
3/4" OD X .065"	5/16-24	C73-841-2	C73-840-2	\$9.40	\$6.49	\$6.17	\$5.55
3/4" OD X .065"	3/8-24	C73-843-2	C73-842-2	\$9.40	\$6.49	\$6.17	\$5.55
3/4" OD X .065"	7/16-20	C73-845-2	C73-844-2	\$9.40	\$6.49	\$6.17	\$5.55
7/8" OD X .058"	3/8-24	C73-859-2	C73-858-2	\$10.30	\$7.11	\$6.75	\$6.08
7/8" OD X .058"	7/16-20	C73-861-2	C73-860-2	\$10.30	\$7.11	\$6.75	\$6.08
7/8" OD X .058"	1/2-20	C73-863-2	C73-862-2	\$10.30	\$7.11	\$6.75	\$6.08
7/8" OD X .065"	3/8-24	C73-865-2	C73-864-2	\$10.30	\$7.11	\$6.75	\$6.08
7/8" OD X .065"	7/16-20	C73-867-2	C73-866-2	\$10.30	\$7.11	\$6.75	\$6.08
7/8" OD X .065"	1/2-20	C73-869-2	C73-868-2	\$10.30	\$7.11	\$6.75	\$6.08
7/8" OD X .083"	3/8-24	C73-871-2	C73-870-2	\$10.30	\$7.11	\$6.75	\$6.08
7/8" OD X .083"	7/16-20	C73-873-2	C73-872-2	\$10.30	\$7.11	\$6.75	\$6.08
7/8" OD X .083"	1/2-20	C73-875-2	C73-874-2	\$10.30	\$7.11	\$6.75	\$6.08
1" OD X .058"	3/8-24	C73-885-2	C73-884-2	\$10.80	\$7.45	\$7.08	\$6.37
1" OD X .058"	7/16-20	C73-887-2	C73-886-2	\$10.80	\$7.45	\$7.08	\$6.37
1" OD X .058"	1/2-20	C73-889-2	C73-888-2	\$10.80	\$7.45	\$7.08	\$6.37
1" OD X .058"	5/8-18	C73-891-2	C73-890-2	\$10.80	\$7.45	\$7.08	\$6.37
1" OD X .065"	3/8-24	C73-893-2	C73-892-2	\$10.80	\$7.45	\$7.08	\$6.37
1" OD X .065"	7/16-20	C73-895-2	C73-894-2	\$10.80	\$7.45	\$7.08	\$6.37
1" OD X .065"	1/2-20	C73-897-2	C73-896-2	\$10.80	\$7.45	\$7.08	\$6.37
1" OD X .065"	5/8-18	C73-899-2	C73-898-2	\$10.80	\$7.45	\$7.08	\$6.37
1" OD X .083"	7/16-20	C73-903-2	C73-902-2	\$10.80	\$7.45	\$7.08	\$6.37
1" OD X .083"	1/2-20	C73-905-2	C73-904-2	\$10.80	\$7.45	\$7.08	\$6.37
1" OD X .083"	5/8-18	C73-907-2	C73-906-2	\$10.80	\$7.45	\$7.08	\$6.37
1-1/8" OD X .058"	1/2-20	C73-917-2	C73-916-2	\$12.50	\$8.63	\$8.20	\$7.38
1-1/8" OD X .058"	5/8-18	C73-919-2	C73-918-2	\$12.50	\$8.63	\$8.20	\$7.38
1-1/8" OD X .065"	1/2-20	C73-923-2	C73-922-2	\$12.50	\$8.63	\$8.20	\$7.38
1-1/8" OD X .065"	5/8-18	C73-925-2	C73-924-2	\$12.50	\$8.63	\$8.20	\$7.38
1-1/8" OD X .065"	3/4-16	C73-927-2	C73-926-2	\$12.50	\$8.63	\$8.20	\$7.38
1-1/8" OD X .083"	1/2-20	C73-929-2	C73-928-2	\$12.50	\$8.63	\$8.20	\$7.38
1-1/8" OD X .083"	5/8-18	C73-931-2	C73-930-2	\$12.50	\$8.63	\$8.20	\$7.38
1-1/8" OD X .083"	3/4-16	C73-933-2	C73-932-2	\$12.50	\$8.63	\$8.20	\$7.38
1-1/4" OD X .095"	5/8-18	C73-941-2	C73-940-2	\$13.90	\$9.59	\$9.11	\$8.20
1-1/4" OD X .095"	3/4-16	C73-943-2	C73-942-2	\$13.90	\$9.59	\$9.11	\$8.20
1-1/4" OD X .120"	5/8-18	C73-945-2	C73-944-2	\$13.90	\$9.59	\$9.11	\$8.20
1-1/4" OD X .120"	3/4-16	N/A	C73-946-2	\$13.90	\$9.59	\$9.11	\$8.20
1-3/8" OD X .095"	5/8-18	C73-949-2	C73-948-2	\$14.50	\$10.01	\$9.51	\$8.56
1-3/8" OD X .095"	3/4-16	N/A	C73-950-2	\$14.50	\$10.01	\$9.51	\$8.56

Our large selection of right and left hand weld-in threaded tube adapters prove to be a great time saver by simplifying linkage construction. Over 100 size and thread combinations are available to choose from. Additional savings can be earned through the quantity discounts listed.



NYLOCK NUTS

Plated steel with nylon insert provides a friction grip, RH UNF thread.



SOLD IN PACKS OF 6

HALF HEIGHT

PART #	DESCRIPTION	PRICE
C73-032	1/4-28	\$1.10
C73-034	5/16-24	\$1.25
C73-036	3/8-24	\$1.50
C73-038	7/16-20	\$2.10
C73-040	1/2-20	\$2.90

SOLD IN PACKS OF 6

FULL HEIGHT

PART #	DESCRIPTION	PRICE
C73-031	10-32	\$0.90
C73-033	1/4-28	\$1.10
C73-035	5/16-24	\$1.25
C73-037	3/8-24	\$1.50
C73-039	7/16-20	\$2.10
C73-041	1/2-20	\$2.90

SOLD IN PACKS OF 4

PART #	DESCRIPTION	PRICE
C73-043	5/8-18	\$4.50
C73-045	3/4-16	\$5.90

JAM NUTS

Plated steel jam nuts provide a positive lock of final adjustments.



SOLD IN PACKS OF 6

DESCRIPTION	LEFT HAND		RIGHT HAND	
	PART #	PRICE	PART #	PRICE
10-32	NA	NA	C73-050	\$0.80
1/4-28	C73-053	\$3.90	C73-052	\$0.80
5/16-24	C73-055	\$4.10	C73-054	\$2.26
3/8-24	C73-057	\$4.40	C73-056	\$2.95
7/16-20	C73-059	\$4.80	C73-058	\$3.60
1/2-20	C73-061	\$4.90	C73-060	\$3.95

SOLD IN PACKS OF 4

DESCRIPTION	LEFT HAND		RIGHT HAND	
	PART #	PRICE	PART #	PRICE
5/8-18	C73-063	\$5.25	C73-062	\$3.50

AN WASHERS

Small OD flat washers are cadmium plated steel .063" thick. Sold in packs of 100.

SOLD IN PACKS OF 100

SIZE	I.D.	O.D.	PART #	PRICE
3/16"	.203"	.438"	C73-010	\$5.95
1/4"	.265"	.500"	C73-011	\$5.95
5/16"	.328"	.562"	C73-012	\$5.95
3/8"	.390"	.625"	C73-013	\$7.95
7/16"	.453"	.750"	C73-014	\$9.95
1/2"	.515"	.875"	C73-015	\$15.95



tube adapters



aurora

The Aurora name is well known in racing for their high quality, reliable rod ends and spherical bearings. Their key metal-to-metal contact between bearing components provide high-strength and smooth operation. We carry a wide selection of mild steel and

chromoly rods ends, and offer additional discounts on purchases of 10 or more pieces. Used in racing and aerospace, Aurora is a name you can depend on for quality, reliability, and performance.



TWO PIECE "C" SERIES (MILD STEEL)

The "C" Series consists of a low carbon steel body (zinc plated) and precision ground oil impregnated sintered steel ball. This construction allows the rod end body to carry a greater static load and offers greater misalignment capabilities.

MALE



BALL DIA	THREAD SIZE	BALL WIDTH	M.A.*	RADIAL LOAD CAPACITY (LBS)	LEFT HAND			RIGHT HAND		
					PART #	PRICE	QTY. (10+)	PART #	PRICE	QTY. (10+)
3/16"	10-32	.312	17	1,204	CB-3	\$5.12	\$4.61	CM-3	\$4.90	\$4.41
1/4"	1/4-28	.375	21	2,212	CB-4	\$5.26	\$4.73	CM-4	\$5.04	\$4.54
5/16"	5/16-24	.437	17	3,577	CB-5	\$5.76	\$5.18	CM-5	\$5.52	\$4.97
3/8"	3/8-24	.500	19	5,068	CB-6	\$6.54	\$5.89	CM-6	\$6.30	\$5.67
7/16"	7/16-20	.562	18	6,345	CB-7	\$7.70	\$6.93	CM-7	\$7.48	\$6.73
1/2"	1/2-20	.625	17	8,338	CB-8	\$9.34	\$8.41	CM-8	\$9.14	\$8.23
5/8"	5/8-18	.750	22	9,713	CB-10	\$12.71	\$11.44	CM-10	\$12.51	\$11.26
3/4"	3/4-16	.875	18	14,207	CB-12	\$17.32	\$15.59	CM-12	\$17.08	\$15.37

* Misalignment angle

FEMALE



BALL DIA	THREAD SIZE	BALL WIDTH	M.A.*	RADIAL LOAD CAPACITY (LBS)	LEFT HAND			RIGHT HAND		
					PART #	PRICE	QTY. (10+)	PART #	PRICE	QTY. (10+)
3/16"	10-32	.312	17	2,079	CG-3	\$4.94	\$4.45	CW-3	\$4.70	\$4.23
1/4"	1/4-28	.375	21	3,208	CG-4	\$5.10	\$4.59	CW-4	\$4.86	\$4.37
5/16"	5/16-24	.437	17	3,824	CG-5	\$5.16	\$4.64	CW-5	\$4.94	\$4.45
3/8"	3/8-24	.500	19	5,087	CG-6	\$6.14	\$5.53	CW-6	\$5.92	\$5.33
7/16"	7/16-20	.562	18	6,385	CG-7	\$7.72	\$6.95	CW-7	\$7.50	\$6.75
1/2"	1/2-20	.625	17	9,096	CG-8	\$10.36	\$9.32	CW-8	\$10.14	\$9.13
5/8"	5/8-18	.750	22	9,713	CG-10	\$12.94	\$11.65	CW-10	\$12.74	\$11.47
3/4"	3/4-16	.875	18	14,207	CG-12	\$17.41	\$15.67	CW-12	\$17.17	\$15.45

* Misalignment angle

TECH TIP

RADIAL STATIC LOAD CAPACITY?

These loads are based upon the minimal mechanical properties of the design configuration of the stressed areas. The Operation Load Capacity of Aurora rod ends is based upon the Radial Static Load Rating. Appropriate safety factors should be utilized with the application. Full rotation assemblies up to 100 rpm should not exceed 10% of the radial static load.



AXIAL LOAD CAPACITY?

Axial static load is the force that is applied through the bore of the ball. Maximum axial static load capacity is recommended at 15% of the radial static load for Aurora two piece rod ends, 10% for three piece rod ends.

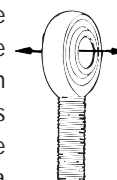

BEARING MISALIGNMENT?

A rod end or spherical bearings ability to misalign is measured by the degree of angle the ball can accommodate without interference.

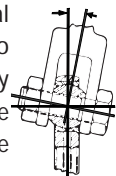

THREE PIECE "A" SERIES (CHROMOLY)

The "A" series consists of a body, ball and race. This type of construction allows for the use of different metals for each component part. The body is manufactured out of 4130 steel alloy, which is heat treated, cadmium plated and chromate treated. Specifications for the race are heat treated alloy steel, zinc plated, and chromate treated materials. The ball is made from 52100 steel (AMS-7440) and is heat treated, and hard chrome plated.



BALL DIA	THREAD SIZE	BALL WIDTH	M.A.*	RADIAL LOAD CAPACITY (LBS)	LEFT HAND			RIGHT HAND		
					PART #	PRICE	QTY. (10+)	PART #	PRICE	QTY. (10+)
3/16"	10/32	.312	13	2,851	AB-3	\$16.80	\$15.12	AM-3	\$16.60	\$14.94
1/4"	1/4-28	.375	16	5,260	AB-4	\$16.82	\$15.14	AM-4	\$16.62	\$14.96
5/16"	5/16-24	.437	14	7,639	AB-5	\$17.08	\$15.37	AM-5	\$16.82	\$15.14
3/8"	3/8-24	.500	12	9,544	AB-6	\$19.88	\$17.89	AM-6	\$19.64	\$17.68
7/16"	7/16-20	.562	14	10,285	AB-7	\$24.44	\$22.00	AM-7	\$24.22	\$21.80
1/2"	1/2-20	.625	12	16,238	AB-8	\$26.59	\$23.93	AM-8	\$26.37	\$23.73
5/8"	5/8-18	.750	16	17,955	AB-10	\$35.64	\$32.08	AM-10	\$35.64	\$32.08
3/4"	3/4-16	.875	14	28,081	AB-12	\$50.42	\$45.38	AM-12	\$50.78	\$45.70

TEFLON LINED

BALL DIA	THREAD SIZE	BALL WIDTH	M.A.*	RADIAL LOAD CAPACITY (LBS)	LEFT HAND			RIGHT HAND		
					PART #	PRICE	QTY. (10+)	PART #	PRICE	QTY. (10+)
3/8"	3/8-24	.500	12	9,544	AB-6T	\$23.04	\$20.74	AM-6T	\$22.78	\$20.50
7/16"	7/16-20	.562	14	10,285	AB-7T	\$27.60	\$24.84	AM-7T	\$27.36	\$24.62
1/2"	1/2-20	.625	12	16,238	AB-8T	\$29.43	\$26.49	AM-8T	\$29.43	\$26.49
5/8"	5/8-18	.750	16	17,955	AB-10T	\$38.48	\$34.63	AM-10T	\$38.25	\$34.43
3/4"	3/4-16	.875	14	28,081	AB-12T	\$53.62	\$48.26	AM-12T	\$53.41	\$48.07

* Misalignment angle

EXTRA HEAVY DUTY "XA" SERIES (CHROMOLY)

The "XA" Series rod ends feature large body and threaded shank with a standard size ball. Three piece construction, with body, ball and race. Materials used in the construction of the "XA" Series are the same as the "A" Series.



BALL DIA	THREAD SIZE	BALL WIDTH	M.A.*	RADIAL LOAD CAPACITY (LBS)	LEFT HAND			RIGHT HAND		
					PART #	PRICE	QTY. (10+)	PART #	PRICE	QTY. (10+)
3/16"	1/4-28	.312	10	5,260	XAB-3	\$16.76	\$15.08	XAM-3	\$16.54	\$14.89
1/4"	5/16-24	.375	13	8,452	XAB-4	\$17.14	\$15.43	XAM-4	\$16.88	\$15.19
5/16"	3/8-24	.437	12	12,978	XAB-5	\$19.92	\$17.93	XAM-5	\$19.70	\$17.73
3/8"	7/16-20	.500	10	17,508	XAB-6	\$24.60	\$22.14	XAM-6	\$24.38	\$21.94
7/16"	1/2-20	.562	12	23,452	XAB-7	\$29.66	\$26.69	XAM-7	\$29.44	\$26.50
1/2"	5/8-18	.625	10	31,390	XAB-8	\$35.55	\$32.00	XAM-8	\$35.37	\$31.83
5/8"	3/4-16	.750	13	40,572	XAB-10	\$50.72	\$45.65	XAM-10	\$50.53	\$45.48

TEFLON LINED

BALL DIA	THREAD SIZE	BALL WIDTH	M.A.*	RADIAL LOAD CAPACITY (LBS)	LEFT HAND			RIGHT HAND		
					PART #	PRICE	QTY. (10+)	PART #	PRICE	QTY. (10+)
1/2"	3/4-16	.625	13	40,572	XAB-8T-2	\$62.57	\$56.31	XAM-8T-2	\$62.57	\$56.31
1/2"	5/8-18	.625	10	31,390	XAB-8T	\$38.39	\$34.55	XAM-8T	\$38.20	\$34.38
5/8"	3/4-16	.750	13	40,572	XAB-10T	\$53.57	\$48.21	XAM-10T	\$53.35	\$48.02

* Misalignment Angle

HIGH MISALIGNMENT SERIES (CHROMOLY)

These special rod high misalignment rod ends are based on the "XA" series. Assembled with a special ball that includes built in shoulders, providing additional misalignment without the use of spacers. The durable Teflon liner provides additional wear resistance.



BALL DIA	THREAD SIZE	BALL WIDTH	M.A.*	RADIAL LOAD CAPACITY (LBS)	LEFT HAND			RIGHT HAND		
					PART #	PRICE	QTY. (10+)	PART #	PRICE	QTY. (10+)
5/16"	7/16-20	.813	22	11,781	HXAB-5T	\$53.78	\$48.40	HXAM-5T	\$53.78	\$48.40
3/8"	7/16-20	.813	22	11,781	HXAB-6T	\$49.12	\$44.21	HXAM-6T	\$49.12	\$44.21
7/16"	1/2-20	.875	21	17,105	HXAB-7T	\$59.11	\$53.20	HXAM-7T	\$59.11	\$53.20
1/2"	5/8-18	.937	19	23,720	HXAB-8T	\$73.12	\$65.81	HXAM-8T	\$73.12	\$65.81
5/8"	3/4-16	1.200	19	32,067	HXAB-10T	\$92.70	\$83.43	HXAM-10T	\$92.70	\$83.43

* Misalignment angle

TECH TIP

PTFE LINER? The military spec Teflon race greatly increases dynamic wear characteristics, making this the ideal choice for 4-links and ladder bars. This PTFE lined option is not to be confused with other rod end manufacturers' soft Nylon races. We do not offer the polished "R" prefix rod ends, as they are weaker than the "A" or "XA" series.

ROD END INSERT

Perfect for shock end bearings and components that don't need adjustability.



PART #	DIMENSION	PRICE	QTY. (10+)
COM-8	1/2" I.D. X 1" O.D.	\$10.64	\$9.58
COM-10	5/8" I.D. X 1-3/16" O.D.	\$10.98	\$9.88
COM-12	3/4" I.D. X 1-7/16" O.D.	\$16.28	\$14.65

TEFLON LINED

PART #	DIMENSION	PRICE	QTY. (10+)
COM8-T	1/2" I.D. X 1" O.D.	\$14.64	\$13.18
COM10-T	5/8" I.D. X 1-3/16" O.D.	\$15.50	\$13.95
COM12-T	3/4" I.D. X 1-7/16" O.D.	\$20.80	\$18.72



SAFETY WASHERS

Precision machined and plated for appearance and long lasting corrosion resistance. Radius "under cut" design allows for increased rod end misalignment angle.

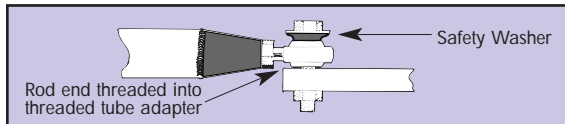

SOLD IN PACKS OF 2

PART #	INSIDE DIA.	OUTSIDE DIA.	THICKNESS	PRICE
C73-463-2	5/16"	7/8"	.170"	\$3.90
C73-464-2	3/8"	1"	.200"	\$3.90
C73-465-2	7/16"	1-1/8"	.220"	\$3.90
C73-466-2	1/2"	1-1/4"	.220"	\$3.90
C73-467-2	5/8"	1-3/8"	.220"	\$4.40
C73-468-2	3/4"	1-5/8"	.330"	\$4.40

STEERING SHAFT SUPPORT

This 3/4-16 RH threaded rod end has a special .005" hole in the oversize ball allowing it to easily accept a 3/4" dia. steering shaft.

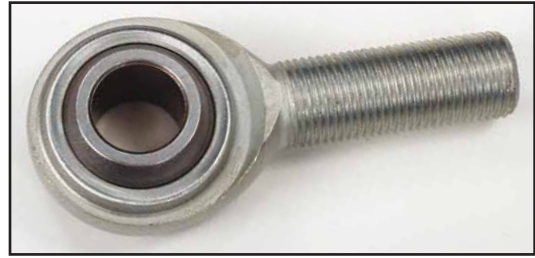

PART #	DIMENSION	PRICE
CM12-12	.755" I.D.	\$19.40

HIGH MISALIGNMENT BUSHINGS

These bushings double as a spacer and increase the misalignment capabilities of rod ends. Hole size is reduced in the ball, see chart for reference.



SOLD IN PACKS OF 2

PART #	O.D.	I.D.	PRICE
C78-010-2	5/8"	1/2"	\$17.95
C78-011-2	3/4"	1/2"	\$17.95
C78-013-2	7/8"	5/8"	\$18.75



Increase Misalignment

SEALS IT WASHERS

Extends rod end life by sealing out dust and foreign debris, fits any style of rod end.



SOLD IN PACKS OF 2

PART #	DESCRIPTION	PRICE
C73-473-2	5/16 ROD END	\$3.94
C73-474-2	3/8 ROD END	\$3.94
C73-475-2	7/16 ROD END	\$3.94
C73-476-2	1/2 ROD END	\$3.94
C73-477-2	5/8 ROD END	\$4.90
C73-478-2	3/4 ROD END	\$5.10



earl's

For over 30 years Earl's has been the number one name in quality components for fluid transfer systems. We stock over 900 part numbers to cover every fluid delivery system plumbing requirement. Earl's hose ends have the largest possible inside

diameter for maximum flow capability, along with a wide selection of adapter fittings. Earl's Perform-O-Flex hose provides maximum flexibility and reliability. We offer an additional 10% discount on all orders over \$300.00.



Buy \$300.00 of Earl's Plumbing and **SAVE** an additional **10%**

earl's

PERFORM-O-FLEX HOSE

Earl's Perform-O-Flex stainless braid-protected synthetic rubber hose is premium quality racing hose depended on by the top racing teams of every professional sanctioning body in the world. The hose is flexible at temperatures ranging from -40° to +300° F. Perform-O-Flex hose is intended for use with Swivel-Seal and Auto-Fit ends only.



PART #	SIZE	I.D.	O.D.	MAX OPERATING PRESSURE	PRICE PER FOOT
400040	4	7/32"	7/16"	1500 PSI	\$6.92
400060	6	11/32"	35/64"	1500 PSI	\$8.19
400080	8	7/16"	41/64"	1500 PSI	\$9.39
400100	10	9/16"	51/64"	1250 PSI	\$10.57
400120	12	11/16"	15/16"	1000 PSI	\$11.37
400160	16	7/8"	1-5/32"	750 PSI	\$14.62
400200	20	1-1/8"	1-7/16"	500 PSI	\$20.35
400240	24	1-3/8"	1-45/64"	250 PSI	\$22.81



HOSE SPRING INSERTS

Inserts into Perform-O-Flex hose to prevent collapsing of hose under vacuum. Ideal for pick-up lines for dry sumps, oil pickups, and injection systems. Sold in 4' lengths.

PART #	DESCRIPTION	PRICE PER LENGTH
770010	#10 SPRING INSERT	\$7.35
770012	#12 SPRING INSERT	\$7.35

Note: 4 ft. Long

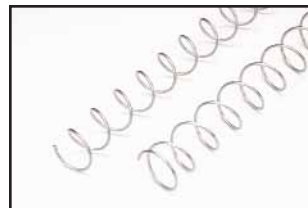

FLAME GUARD INSULATION

Provides insulation of hoses or cables from heat sources. This red non-asbestos sleeve has an operating temperature of -65° to +500° F, with splashes to 2000°F. Sold by the foot.

PART #	ID	FITS HOSE	PRICE PER FOOT
730006	3/8"	-3 & -4 SPEED-FLEX	\$5.89
730008	1/2"	-4 PERFORM-O-FLEX	\$6.84
730010	3/4"	-6 & -8 PERFORM-O-FLEX	\$8.79
730012	1"	-10 & -12 PERFORM-O-FLEX	\$12.16
730014	1-1/4"	-16 PERFORM-O-FLEX	\$14.19
730016	1-1/2"	-18 & -20 PERFORM-O-FLEX	\$14.98

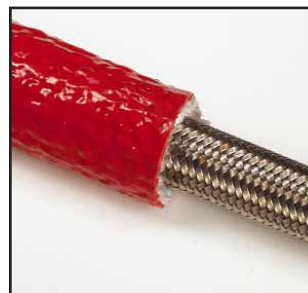

ECON-O-FIT HOSE ENDS

The appearance of the Econ-O-Fit hose ends dresses up any installation. The specially designed interior grooving prevents the hose from "hanging up" on the clamp and assures proper placement of the worm gear type clamp. The Econ-O-Fit hose ends are quality machined from aluminum alloy and anodized red for durability. To be used with Perform-O-Flex hose.



PART #	SIZE	I.D.	PRICE
900104	4	1/2"	\$4.66
900106	6	5/8"	\$4.66
900108	8	11/16"	\$4.97
900110	10	13/16"	\$5.89
900112	12	15/16"	\$6.68
900114	14	1-1/8"	\$10.85
900116	16	1-3/16"	\$10.85
900118	18	1-3/8"	\$13.35
900120	20	1-1/2"	\$13.35
900124	24	1-3/4"	\$18.33
900128	28	1-15/16"	\$18.33
900132	32	2-3/16"	\$20.03

HOSE AND TUBING SEPARATORS

Crafted from 6061-T6 billet aluminum alloy, these clamps and hose & wire separators are perfect for separating, isolating, and securing fuel and oil lines, brake hoses, and even wiring looms.



PKG. QTY.	RED ANODIZED	BLUE ANODIZED	POLISHED	SIZE	APPLICATION	PRICE
3	167003	167103	167203	3/16	VARIOUS	\$19.64
3	167004	167104	167204	1/4	#3 SPEED FLEX	\$19.64
3	167005	167105	167205	5/16	#4 SPEED FLEX	\$19.64
2	167006	167106	167206	3/8	VARIOUS	\$19.64
2	167007	167107	167207	7/16	#4 PERFORM-O-FLEX	\$19.64
2	167008	167108	167208	1/2	VARIOUS	\$19.64
2	167009	167109	167209	9/16	#6 PERFORM-O-FLEX	\$19.64
2	167022	167122	167222	21/32	#8 PERFORM-O-FLEX	\$19.64
2	167013	167113	167213	13/16	#10 PERFORM-O-FLEX	\$19.64
2	167015	167115	167215	15/16	#12 PERFORM-O-FLEX	\$19.64
2	167017	167117	167217	1-1/16	#16 PERFORM-O-FLEX	\$19.64

LINE CLAMPS

Ideal for securing individual lines, hoses, or wiring. These durable billet aluminum clamps are available in several color options.

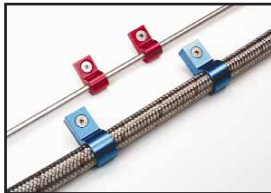

PKG. QTY.	RED ANODIZED	BLUE ANODIZED	POLISHED	SIZE	APPLICATION	PRICE
6	170003	170103	170203	3/16	VARIOUS	\$19.64
6	170004	170104	170204	1/4	#3 SPEED FLEX	\$19.64
6	170005	170105	170205	5/16	#4 SPEED FLEX	\$19.64
4	170006	170106	170206	3/8	VARIOUS	\$19.64
4	170007	170107	170207	7/16	#4 PERFORM-O-FLEX	\$19.64
3	170008	170108	170208	1/2	VARIOUS	\$19.64
3	170009	170109	170209	9/16	#6 PERFORM-O-FLEX	\$19.64

CUSHIONED TUBING CLAMPS

These clamps are designed to support and locate hoses. They are attached to the supporting structure with either a machine screw and nut or in blind applications with a machine screw and a rivnut or plate nut.

PKG. QTY.	PART #	FITS TUBE OR HOSE O.D.	PRICE
10	171003	3/16"	\$10.92
10	171004	1/4"	\$10.92
10	171005	5/16"	\$10.92
10	171006	3/8"	\$10.92
5	171008	1/2"	\$7.35
5	171010	5/8"	\$7.35
5	171012	3/4"	\$7.35
5	171016	1"	\$7.35
2	171018	1-1/8"	\$4.56
2	171020	1-1/4"	\$4.56



HOSE END WRENCHES

These wrenches are designed to prevent over tightening and scratching of fittings. Fits all AN type fittings and hose ends. Machined from billet aluminum and color coded (anodized) for quick size identification.



PART #	HEX SIZE	HOSE END SIZE	PRICE
230406	11/16"	6	\$17.45
230408	7/8"	8	\$17.45
230410	1"	10	\$17.45
230412	1-1/4"	12	\$21.09
230416	1-1/2"	16	\$21.09

DOUBLE ENDED HOSE END WRENCHES

These new dual purpose aluminum wrenches can be used for hose end installation on hose and for maintenance. Durable anodized finish.



PART #	HEX SIZE	FITS	PRICE
230405	9/16" X 1/2"	4 NUT - 3 NUT	\$17.45
230407	11/16" X 5/8"	6 NUT - 4 SOCKET	\$17.45
230409	7/8" X 3/4"	8 NUT - 6 SOCKET	\$17.45
230411	1" X 7/8"	10 NUT - 8 SOCKET	\$17.45
230413	1-1/4" X 1-1/16"	12 NUT - 10 SOCKET	\$21.09
230415	1-1/2" X 1-3/16"	16 NUT - 12 SOCKET	\$21.09

AUTO-FIT HOSE ENDS

Auto-Fit ends provide the reliability and appearance of Swivel-Seal but are less expensive. The Auto-Fit nipple is pushed into rather than threaded into the hose. The hose is compressed between the nipple and the socket, sealing at the barbs. Hose retention is positive (the same as Swivel-Seal) and there is no spiral path for possible leaks.

STRAIGHT

PART #	HOSE		ADAPTER	PRICE
	END SIZE	USE HOSE		
300104	4	4	4	\$7.07
300106	6	6	6	\$7.52
300108	8	8	8	\$9.61
300110	10	10	10	\$12.16
300112	12	12	12	\$17.91



45° BENT TUBE

PART #	HOSE		ADAPTER	PRICE
	END SIZE	USE HOSE		
304604	4	4	4	\$18.33
304606	6	6	6	\$19.24
304608	8	8	8	\$22.57
304610	10	10	10	\$26.70
304612	12	12	12	\$33.42



90° BENT TUBE

PART #	HOSE		ADAPTER	PRICE
	END SIZE	USE HOSE		
309104	4	4	4	\$18.33
309106	6	6	6	\$19.24
309108	8	8	8	\$22.57
309110	10	10	10	\$26.70
309112	12	12	12	\$33.42



120° BENT TUBE

PART #	HOSE		ADAPTER	PRICE
	END SIZE	USE HOSE		
312004	4	4	4	\$23.38
312006	6	6	6	\$23.38
312008	8	8	8	\$28.18
312010	10	10	10	\$30.72
312012	12	12	12	\$35.21



150° BENT TUBE

PART #	HOSE		ADAPTER	PRICE
	END SIZE	USE HOSE		
315006	6	6	6	\$23.38
315008	8	8	8	\$28.18
315010	10	10	10	\$30.72
315012	12	12	12	\$35.21



180° BENT TUBE

PART #	HOSE		ADAPTER	PRICE
	END SIZE	USE HOSE		
318004	4	4	4	\$23.38
318006	6	6	6	\$23.38
318008	8	8	8	\$28.18
318010	10	10	10	\$30.72
318012	12	12	12	\$35.21



STRAIGHT WITH MALE PIPE THREAD

PART #	HOSE		NPT THD.	PRICE
	END SIZE	USE HOSE		
320104	4	1/8"	\$7.07	
320144	4	1/4"	\$7.67	
320162	6	1/8"	\$7.67	
320106	6	1/4"	\$7.07	
320166	6	3/8"	\$9.71	
320107	8	1/4"	\$9.14	
320108	8	3/8"	\$9.14	
320188	8	1/2"	\$12.25	
320111	10	3/8"	\$11.65	
320110	10	1/2"	\$11.65	
320112	12	3/4"	\$17.17	
320113	12	1/2"	\$17.17	



TUBE-MATE

Designed to connect flexible hose directly to low pressure tubing (25-PSI max.). Tubing should be flared, beaded, or grooved for secure installation.

PART #	HOSE		TUBING	PRICE
	END SIZE	USE HOSE		
360104	4	1/4"	\$10.10	
360165	6	5/16"	\$10.10	
360106	6	3/8"	\$10.10	
360108	8	1/2"	\$12.72	
360110	10	5/8"	\$17.17	
360112	12	3/4"	\$25.36	



SWIVEL-SEAL HOSE ENDS

Earl's patented Swivel-Seal hose ends incorporate the finest design qualities of any hose end made. The Earl's Swivel-Seal hose end includes a feature not found on other hose ends - **adjustability after assembly**. It is this feature that makes Earl's patented Swivel-Seal hose end the only choice for true high performance applications. Available in beautiful anodized red and blue finishes.

STRAIGHT

PART #	HOSE		ADAPTER		PRICE
	END SIZE	USE HOSE	SIZE	SIZE	
800106	6	6	6	6	\$7.52
800108	8	8	8	8	\$10.02
800110	10	10	10	10	\$12.96
800112	12	12	12	12	\$18.33
800116	16	16	16	16	\$29.25



45° LOW PROFILE

PART #	HOSE		ADAPTER		PRICE
	END SIZE	USE HOSE	SIZE	SIZE	
804506	6	6	6	6	\$22.96
804508	8	8	8	8	\$27.86
804510	10	10	10	10	\$34.22
804512	12	12	12	12	\$42.60
804516	16	16	16	16	\$60.20

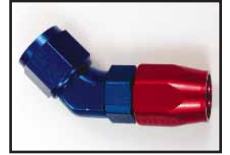

45° BENT TUBE

PART #	HOSE		ADAPTER		PRICE
	END SIZE	USE HOSE	SIZE	SIZE	
804606	6	6	6	6	\$21.26
804608	8	8	8	8	\$25.92
804610	10	10	10	10	\$30.09
804612	12	12	12	12	\$37.55
804616	16	16	16	16	\$45.85



90° LOW PROFILE

PART #	HOSE		ADAPTER		PRICE
	END SIZE	USE HOSE	SIZE	SIZE	
809006	6	6	6	6	\$22.96
809008	8	8	8	8	\$27.86
809010	10	10	10	10	\$34.22
809012	12	12	12	12	\$42.60
809016	16	16	16	16	\$60.20

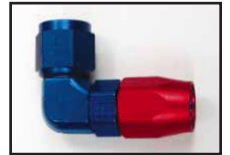

90° BENT TUBE

PART #	HOSE		ADAPTER		PRICE
	END SIZE	USE HOSE	SIZE	SIZE	
809106	6	6	6	6	\$21.26
809108	8	8	8	8	\$25.92
809110	10	10	10	10	\$30.09
809112	12	12	12	12	\$37.55
809116	16	16	16	16	\$45.95

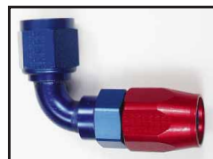

120° BENT TUBE

PART #	HOSE		ADAPTER		PRICE
	END SIZE	USE HOSE	SIZE	SIZE	
812006	6	6	6	6	\$24.20
812008	8	8	8	8	\$29.25
812010	10	10	10	10	\$32.59
812012	12	12	12	12	\$39.66
812016	16	16	16	16	\$64.25



150° BENT TUBE

PART #	HOSE		ADAPTER		PRICE
	END SIZE	USE HOSE	SIZE	SIZE	
815006	6	6	6	6	\$24.20
815008	8	8	8	8	\$29.25
815010	10	10	10	10	\$32.59
815012	12	12	12	12	\$39.66
815016	16	16	16	16	\$64.25



180° BENT TUBE

PART #	HOSE		ADAPTER		PRICE
	END SIZE	USE HOSE	SIZE	SIZE	
818006	6	6	6	6	\$24.20
818008	8	8	8	8	\$29.25
818010	10	10	10	10	\$32.59
818012	12	12	12	12	\$39.66
818016	16	16	16	16	\$64.25



SINGLE BANJO HOSE END



PART #	SIZE	HOSE END SIZE	APPLICATION	PRICE
807691	12mm X 1.25	6	DELLORTO, SOLEX, MIKUNI	\$20.87
807692	12 mm X 1.5	6	WEBER	\$20.87
807694	9/16"-24	6	SMALL INLET HOLLEY	\$20.87
807695	1/2"-20	6	FUEL PUMP	\$20.87

DOUBLE BANJO HOSE END



PART #	SIZE	HOSE END SIZE	APPLICATION	PRICE
807991	12mm X 1.25	6	DELLORTO, SOLEX, MIKUNI	\$30.87
807992	12 mm X 1.5	6	WEBER	\$30.87
807994	9/16"-24	6	SMALL INLET HOLLEY	\$30.87
807995	1/2"-20	6	FUEL PUMP	\$30.87

MALE PIPE THREADS

STRAIGHT

PART #	HOSE SIZE	MALE THREAD SIZE	PRICE
820162	6	1/8 NPT	\$12.47
820106	6	1/4 NPT	\$12.47
820166	6	3/8 NPT	\$15.22
820107	8	1/4 NPT	\$15.22
820108	8	3/8 NPT	\$15.22
820188	8	1/2 NPT	\$20.20
820111	10	3/8 NPT	\$20.20
820110	10	1/2 NPT	\$20.20
820113	12	1/2 NPT	\$31.19
820112	12	3/4 NPT	\$31.19



MALE AN THREADS

STRAIGHT

PART #	HOSE SIZE	MALE THREAD SIZE	PRICE
840106	6	9/16-18 (AN-6)	\$13.74
840108	8	3/4-16 (AN-8)	\$16.53
840110	10	7/8-14 (AN-10)	\$22.96
840112	12	1-1/16-12 (AN-12)	\$34.45

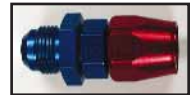

45°

PART #	HOSE SIZE	MALE THREAD SIZE	PRICE
824562	6	1/8 NPT	\$31.19
824506	6	1/4 NPT	\$31.19
824566	6	3/8 NPT	\$31.19
824507	8	1/4 NPT	\$35.85
824508	8	3/8 NPT	\$35.85
824588	8	1/2 NPT	\$35.85
824511	10	3/8 NPT	\$38.63
824510	10	1/2 NPT	\$38.63
824513	12	1/2 NPT	\$53.30
824512	12	3/4 NPT	\$53.30



45°

PART #	HOSE SIZE	MALE THREAD SIZE	PRICE
844564	6	7/16-20 (AN-4)	\$31.19
844565	6	1/2-20 (AN-5)	\$31.19
844506	6	9/16-18 (AN-6)	\$31.19
844568	6	3/4-16 (AN-8)	\$35.85
844586	8	9/16-18 (AN-6)	\$31.19
844508	8	3/4-16 (AN-8)	\$35.85
844581	8	7/8-14 (AN-10)	\$35.85
844509	10	3/4-16 (AN-8)	\$38.63
844510	10	7/8-14 (AN-10)	\$38.63
844511	10	1-1/16-12 (AN-12)	\$53.30
844513	12	7/8-14 (AN-10)	\$53.30
844512	12	1-1/16-12 (AN-12)	\$53.30



90°

PART #	HOSE SIZE	MALE THREAD SIZE	PRICE
829062	6	1/8 NPT	\$31.19
829006	6	1/4 NPT	\$31.19
829066	6	3/8 NPT	\$31.19
829007	8	1/4 NPT	\$35.85
829008	8	3/8 NPT	\$35.85
829088	8	1/2 NPT	\$35.85
829011	10	3/8 NPT	\$38.63
829010	10	1/2 NPT	\$38.63
829013	12	1/2 NPT	\$53.30
829012	12	3/4 NPT	\$53.30



90°

PART #	HOSE SIZE	MALE THREAD SIZE	PRICE
849064	6	7/16-20 (AN-4)	\$31.19
849065	6	1/2-20 (AN-5)	\$31.19
849006	6	9/16-18 (AN-6)	\$31.19
849068	6	3/4-16 (AN-8)	\$31.19
849086	8	9/16-18 (AN-6)	\$35.85
849008	8	3/4-16 (AN-8)	\$35.85
849081	8	7/8-14 (AN-10)	\$35.85
849009	10	3/4-16 (AN-8)	\$38.63
849010	10	7/8-14 (AN-10)	\$38.63
849011	10	1-1/16-12 (AN-12)	\$53.30
849013	12	7/8-14 (AN-10)	\$53.30
849012	12	1-1/16-12 (AN-12)	\$53.30



ALUMINUM ADAPTERS

SAVE 10% - Buy \$300.00

HOSE BARB TO PIPE ADAPTERS

STRAIGHT



PART #	HOSE I.D.	PIPE THREAD	PRICE
984004	1/4"	1/8"	\$3.74
984006	3/8"	1/4"	\$3.74
984008	1/2"	3/8"	\$7.52
984010	5/8"	1/2"	\$11.16
984012	3/4"	3/4"	\$18.68

45°

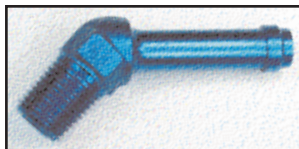

PART #	HOSE I.D.	PIPE THREAD	PRICE
984404	1/4"	1/8"	\$18.68
984406	3/8"	1/4"	\$18.68
984408	1/2"	3/8"	\$18.68
984410	5/8"	1/2"	\$23.28
984412	3/4"	3/4"	\$37.23

90°



PART #	HOSE I.D.	PIPE THREAD	PRICE
984204	1/4"	1/8"	\$18.68
984206	3/8"	1/4"	\$18.68
984208	1/2"	3/8"	\$18.68
984210	5/8"	1/2"	\$23.28
984212	3/4"	3/4"	\$37.23

PIPE TO AN ADAPTERS

STRAIGHT



PART #	FITTING SIZE	PIPE THREAD	PRICE
981603	3	1/8"	\$2.51
981604	4	1/8"	\$2.51
981644	4	1/4"	\$2.94
981606	6	1/4"	\$3.10
981662	6	1/8"	\$3.35
981666	6	3/8"	\$4.17
981668	6	1/2"	\$5.89
981688	8	1/2"	\$5.89
981607	8	1/4"	\$3.89
981608	8	3/8"	\$3.89
981609	10	3/4"	\$9.78
981610	10	1/2"	\$5.89
981611	10	3/8"	\$5.89
981612	12	3/4"	\$10.42
981613	12	1/2"	\$10.42
981615	16	3/4"	\$20.87
981616	16	1"	\$20.87

45° ELBOW



PART #	FITTING SIZE	PIPE THREAD	PRICE
982303	3	1/8"	\$8.38
982304	4	1/8"	\$7.52
982344	4	1/4"	\$8.38
982362	6	1/8"	\$10.25
982306	6	1/4"	\$8.38
982366	6	3/8"	\$11.65
982368	6	1/2"	\$18.68
982307	8	1/4"	\$13.95
982308	8	3/8"	\$10.25
982388	8	1/2"	\$16.77
982311	10	3/8"	\$16.77
982310	10	1/2"	\$16.77
982309	10	3/4"	\$23.28
982313	12	1/2"	\$23.28
982312	12	3/4"	\$23.28
982316	16	1"	\$37.23

90° ELBOW



PART #	FITTING SIZE	PIPE THREAD	PRICE
982203	3	1/8"	\$8.38
982204	4	1/8"	\$7.52
982244	4	1/4"	\$8.38
982206	6	1/4"	\$8.38
982266	6	3/8"	\$11.65
982268	6	1/2"	\$18.33
982262	6	1/8"	\$10.02
982207	8	1/4"	\$14.19
982208	8	3/8"	\$10.42
982288	8	1/2"	\$18.33
982209	10	3/4"	\$22.96
982210	10	1/2"	\$16.70
982211	10	3/8"	\$16.70
982212	12	3/4"	\$23.38
982213	12	1/2"	\$23.38
982215	16	3/4"	\$37.55
982216	16	1"	\$37.55

TEE PIPE THREAD ON SIDE



PART #	FITTING SIZE	PIPE THREAD	PRICE
982503	3	1/8"	\$10.25
982504	4	1/8"	\$9.39
982506	6	1/4"	\$11.16
982508	8	3/8"	\$16.77
982510	10	1/2"	\$18.68
982512	12	3/4"	\$32.59

TEFLON TAPE

Every time you install a tapered pipe thread fitting it is essential to use some form of anti-seize to prevent galling. Earl's teflon tape is easy to use, not messy, and forms a positive seal.



PART #	DESCRIPTION	PRICE
175002	1/2" X 520"	\$5.12

TEE PIPE THREAD ON RUN



PART #	FITTING SIZE	PIPE THREAD	PRICE
982603	3	1/8"	\$12.16
982604	4	1/8"	\$9.39
982606	6	1/4"	\$11.16
982608	8	3/8"	\$16.77
982610	10	1/2"	\$18.68
982612	12	3/4"	\$32.59

PIPE TO AN ADAPTERS

FEMALE AN SWIVEL TO MALE PIPE THREAD



90° MALE AN TO MALE SWIVEL PIPE THREAD



90° FEMALE AN TO MALE SWIVEL PIPE THREAD



PART #	HOSE END	NPT THD.	PRICE
	SIZE	THREAD	
916103	3	1/8"	\$9.93
916104	4	1/8"	\$7.98
916144	4	1/4"	\$7.98
916106	6	1/4"	\$7.98
916162	6	1/8"	\$9.71
916166	6	3/8"	\$10.42
916107	8	1/4"	\$10.42
916108	8	3/8"	\$10.42
916188	8	1/2"	\$12.88
916110	10	1/2"	\$13.67
916111	10	3/8"	\$12.88
916113	12	1/2"	\$20.03
916112	12	3/4"	\$20.03

PART #	HOSE END	NPT THD.	PRICE
	SIZE	THREAD	
922103	3	1/8"	\$21.90
922104	4	1/8"	\$14.66
922144	4	1/4"	\$18.33
922106	6	1/4"	\$14.66
922162	6	1/8"	\$18.33
922166	6	3/8"	\$22.96
922107	8	1/4"	\$22.96
922108	8	3/8"	\$22.96
922188	8	1/2"	\$27.55
922110	10	1/2"	\$30.31
922111	10	3/8"	\$30.31
922113	12	1/2"	\$36.76
922112	12	3/4"	\$36.76

PART #	HOSE END	NPT THD.	PRICE
	SIZE	THREAD	
923103	3	1/8"	\$32.18
923104	4	1/8"	\$22.96
923144	4	1/4"	\$22.96
923106	6	1/4"	\$22.96
923162	6	1/8"	\$22.96
923166	6	3/8"	\$22.96
923107	8	1/4"	\$27.55
923108	8	3/8"	\$27.55
923188	8	1/2"	\$27.55
923110	10	1/2"	\$33.06
923111	10	3/8"	\$33.06
923113	12	1/2"	\$45.95
923112	12	3/4"	\$45.95

PIPE THREAD TO PIPE THREAD ADAPTERS

45° ELBOW MALE TO FEMALE



PART #	PIPE	PRICE
	THREAD	
991501	1/8"	\$13.95
991502	1/4"	\$16.38
991503	3/8"	\$23.28

90° ELBOW MALE TO FEMALE



PART #	PIPE	PRICE
	THREAD	
991401	1/8"	\$13.95
991402	1/4"	\$16.38
991403	3/8"	\$23.28

NIPPLE



PART #	PIPE	PRICE
	THREAD	
991101	1/8"	\$2.43
991102	1/4"	\$3.74
991103	3/8"	\$6.53
991104	1/2"	\$8.38
991106	3/4"	\$9.54

COUPLING



PART #	PIPE	PRICE
	THREAD	
991001	1/8"	\$3.25
991002	1/4"	\$3.74
991003	3/8"	\$6.53
991004	1/2"	\$10.25
991006	3/4"	\$15.82

90° ELBOW FEMALE



PART #	PIPE	PRICE
	THREAD	
991601	1/8"	\$13.95
991602	1/4"	\$16.38
991603	3/8"	\$23.28

TEE FEMALE



PART #	PIPE	PRICE
	THREAD	
991701	1/8"	\$13.95
991702	1/4"	\$16.38
991703	3/8"	\$23.28

REDUCER BUSHING



PART #	THREAD		PRICE
	FEMALE	MALE	
991201	1/8"	1/4"	\$3.74
991202	1/4"	3/8"	\$4.24
991203	1/8"	3/8"	\$4.24
991204	3/8"	1/2"	\$4.66
991205	1/4"	1/2"	\$5.68
991206	1/8"	1/2"	\$5.68

PART #	THREAD		PRICE
	FEMALE	MALE	
991207	1/2"	3/4"	\$9.39
991208	3/8"	3/4"	\$9.39
991209	1/4"	3/4"	\$11.16
991210	3/4"	1"	\$13.95
991211	1/2"	1"	\$13.95
991212	3/8"	1"	\$13.95

AN TO AN ADAPTERS

UNION

PART #	FITTING	
	SIZE	PRICE
981503	3	\$2.94
981504	4	\$2.94
981506	6	\$3.10
981508	8	\$4.97
981510	10	\$6.28
981512	12	\$12.16
981516	16	\$20.87



90° ELBOW

PART #	FITTING	
	SIZE	PRICE
982103	3	\$8.38
982104	4	\$7.52
982106	6	\$8.38
982108	8	\$11.16
982110	10	\$16.77
982112	12	\$24.20
982116	16	\$37.23



TEE

PART #	FITTING	
	SIZE	PRICE
982403	3	\$9.39
982404	4	\$9.39
982406	6	\$9.39
982408	8	\$18.68
982410	10	\$22.33
982412	12	\$29.73
982416	16	\$46.53



FEMALE AN TEE

PART #	FITTING	
	SIZE	PRICE
993804	4	\$18.68
993806	6	\$18.68
993808	8	\$23.28
993810	10	\$27.86
993812	12	\$37.23



AN REDUCER

PART #	FEMALE FITTING	MALE FITTING	PRICE
	SIZE	SIZE	
989404	10	8	\$18.68
989409	12	8	\$27.86
989410	12	10	\$27.86
989443	4	3	\$7.91
989464	6	4	\$7.91
989486	8	6	\$10.25

FEMALE SWIVEL TO
FEMALE SWIVEL COUPLING

PART #	FITTING	
	SIZE	PRICE
915103	3	\$6.43
915104	4	\$6.43
915106	6	\$6.43
915108	8	\$7.98
915186	8-6	\$7.98
915110	10	\$10.42
915112	12	\$14.42
915116	16	\$20.03

90° FEMALE SWIVEL TO FEMALE
SWIVEL- LOW PROFILE

PART #	HOSE END	
	SIZE	PRICE
934103	3	\$11.97
934104	4	\$11.97
934106	6	\$11.97
934108	8	\$16.53
934110	10	\$21.09
934112	12	\$27.55

90° FEMALE SWIVEL TO
FEMALE SWIVEL TUBE

PART #	HOSE END	
	SIZE	PRICE
935103	3	\$12.96
935104	4	\$12.96
935106	6	\$12.96
935108	8	\$15.90
935110	10	\$20.87
935112	12	\$24.76

45° FEMALE SWIVEL TO
FEMALE SWIVEL- LOW PROFILE

PART #	HOSE END	
	SIZE	PRICE
939103	3	\$11.97
939104	4	\$11.97
939106	6	\$11.97
939108	8	\$16.53
939110	10	\$21.09



BULKHEAD NUT

PART #	FITTING	QTY.	PER	PRICE
	SIZE	PKG.	PKG.	
592403	3	2	\$2.11	
592404	4	2	\$2.11	
592406	6	2	\$2.11	
992408	8	1	\$2.43	
992410	10	1	\$2.43	
992412	12	1	\$2.86	
992416	16	1	\$5.68	



STRAIGHT BULKHEAD

PART #	FITTING		PRICE
	SIZE		
983203	3		\$4.66
983204	4		\$3.25
983206	6		\$4.66
983208	8		\$7.52
983210	10		\$11.16
983212	12		\$13.95
983216	16		\$27.86



REDUCER UNION

PART #	FITTING		PRICE
	LARGE	SMALL	
991902	4	3	\$4.24
991906	6	4	\$4.66
991912	8	6	\$6.53
991914	10	6	\$9.39
991915	10	8	\$9.39
991918	12	6	\$13.95
991919	12	8	\$13.95
991920	12	10	\$13.95
991922	16	10	\$20.42
991923	16	12	\$20.42



45° BULKHEAD

PART #	FITTING		PRICE
	SIZE		
983703	3		\$9.39
983704	4		\$6.99
983706	6		\$9.39
983708	8		\$13.95
983710	10		\$18.68
983712	12		\$27.86



45° FEMALE SWIVEL TO MALE AN

PART #	FITTING		PRICE
	SIZE		
924103	3		\$21.09
924104	4		\$13.74
924106	6		\$15.65
924108	8		\$22.96
924110	10		\$30.31
924112	12		\$36.76



90° BULKHEAD

PART #	FITTING		PRICE
	SIZE		
983303	3		\$9.39
983304	4		\$6.99
983306	6		\$9.39
983308	8		\$13.95
983310	10		\$18.68
983312	12		\$27.86



90° FEMALE SWIVEL TO MALE AN

PART #	FITTING		PRICE
	SIZE		
921103	3		\$21.09
921104	4		\$13.74
921106	6		\$14.66
921108	8		\$22.96
921110	10		\$30.31
921112	12		\$36.76



BULKHEAD TEE ON SIDE

PART #	FITTING		PRICE
	SIZE		
983403	3		\$17.69
983404	4		\$12.64
983406	6		\$14.90
983408	8		\$18.68
983410	10		\$18.68
983412	12		\$37.23



TEE SWIVEL ON SIDE

PART #	FITTING		PRICE
	SIZE		
925103	3		\$32.18
925104	4		\$15.65
925106	6		\$18.33
925108	8		\$27.55
925110	10		\$33.06



BULKHEAD TEE ON RUN

PART #	FITTING		PRICE
	SIZE		
980404	4		\$13.28
980406	6		\$13.28
980408	8		\$22.18



TEE SWIVEL ON RUN

PART #	FITTING		PRICE
	SIZE		
926103	3		\$32.18
926104	4		\$15.65
926106	6		\$18.33
926108	8		\$27.55
926110	10		\$32.18

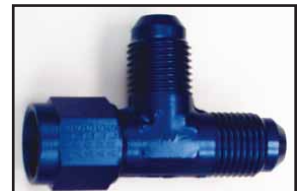

CAPS, PLUGS, AND SEALS

AN PORT ADAPTER

Port end inlet is contoured for maximum flow.

PART #	AN SIZE	PORT THD.	PRICE
985064	6	7/16"-20	\$9.39
985065	6	1/2"-20	\$9.39
985006	6	9/16"-18	\$9.39
985068	6	3/4"-16	\$11.65
985086	8	9/16"-18	\$11.65
985008	8	3/4"-16	\$11.65
985081	8	7/8"-14	\$14.90
985009	10	3/4"-16	\$14.90
985010	10	7/8"-14	\$14.90
985011	10	1-1/16"-12	\$21.41
985013	12	7/8"-14	\$21.41
985012	12	1-1/16"-12	\$21.41



AN FLARE PLUG

PART #	QTY. PER PACKAGE	FITTING SIZE	PRICE
580603	2	3	\$3.35
580604	2	4	\$3.35
580606	2	6	\$3.35
980608	1	8	\$2.71
980610	1	10	\$3.50
980612	1	12	\$5.37
980616	1	16	\$7.07



AN FLARE CAP

PART #	QTY. PER PACKAGE	FITTING SIZE	PRICE
592903	2	3	\$4.17
592904	2	4	\$4.17
592906	2	6	\$4.17
992908	1	8	\$4.24
992910	1	10	\$5.68
992912	1	12	\$7.52
992916	1	16	\$9.39



NPT ALLEN HEAD PLUG

PART #	QTY. PER PACKAGE	PIPE THD. SIZE	PRICE
593201	2	1/16"	\$5.89
593202	2	1/8"	\$5.89
593203	2	1/4"	\$5.89
593204	2	3/8"	\$6.68
993205	1	1/2"	\$3.74
993206	1	3/4"	\$4.66

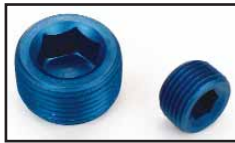

NPT HEX HEAD PLUG

PART #	PIPE THD. SIZE	PRICE
993301	1/8"	\$2.11
993302	1/4"	\$3.10
993303	3/8"	\$3.10
993304	1/2"	\$4.88
993306	3/4"	\$6.04

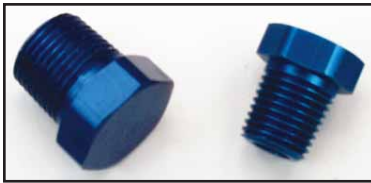

AN PORT PLUG

PART #	QTY. PER PACKAGE	FITTING SIZE	PRICE
581403	2	3	\$4.17
581404	2	4	\$4.97
581406	2	6	\$4.97
981408	1	8	\$3.50
981410	1	10	\$5.37
981412	1	12	\$7.91
981416	1	16	\$10.57



AN FLARE PLUG (PLASTIC)

PART #	QTY. PER PACKAGE	FITTING SIZE	PRICE
179203	25	3	\$7.67
179204	25	4	\$7.67
179206	25	6	\$7.67
179208	15	8	\$7.67
179210	15	10	\$7.67
179212	10	12	\$7.67
179216	10	16	\$7.67



AN FLARE CAP (PLASTIC)

PART #	QTY. PER PACKAGE	FITTING SIZE	PRICE
179103	25	3	\$7.67
179104	25	4	\$7.67
179106	25	6	\$7.67
179108	15	8	\$7.67
179110	15	10	\$7.67
179112	10	12	\$7.67
179116	10	16	\$7.67



BUNA "O" RINGS

To be used with straight threaded adapter fittings when sealing at an AN port.



PART #	QTY. PER PACKAGE	FITTING SIZE	PRICE
176003	10	3	\$4.56
176004	10	4	\$4.56
176006	10	6	\$4.56
176008	10	8	\$4.56
176010	5	10	\$5.29
176012	5	12	\$5.29
176016	5	16	\$5.29

STAT-O-SEALS

Consists of a synthetic rubber "O" ring mechanically locked to the I.D. of an aluminum washer. When tightened, the "O" ring is compressed forcing the sealing surfaces around the bolt shank. They will form a positive seal over a temperature range of -85° F. to +450° F. They provide the advantages of an "O" ring type seal without the necessity of machining "O" ring grooves into the part. 2 seals per pkg.

PART #	I.D.	PRICE
178006	3/8"	\$3.25
178007	7/16"	\$3.25
178008	1/2"	\$4.24
178009	9/16"	\$4.24
178010	5/8"	\$5.97



NYLON BULKHEAD

WASHERS

Used to seal AN bulkhead fittings when used in plastic fuel cells. Sold ea.



PART #	FITTING SIZE	PRICE
850-506-04	6	\$1.95
850-508-04	8	\$1.95
850-510-04	10	\$1.95
850-512-04	12	\$1.95
850-516-04	16	\$1.95

SHUT OFF VALVE

Features 350# PSI maximum. Ideal for use as an emergency fuel shut-off valve, anti-theft device, drain valve, or oil cooler shut-off valve.



PART #	INLET THD. SIZE	OUTLET THD. SIZE	OVERALL LENGTH	BODY MATERIAL	PRICE
230501	3/8" FEM. NPT	3/8" FEM. NPT	1-3/4"	CHROME PLATED BRASS	\$27.77
230502	3/8" FEM. NPT	6 AN BULKHEAD	2-3/4"	RED ANODIZED ALUM.	\$34.69
230503	3/8" FEM. NPT	8 AN BULKHEAD	2-3/4"	RED ANODIZED ALUM.	\$34.69
230504	1/2" FEM. NPT	1/2" FEM. NPT	2-1/4"	CHROME PLATED BRASS	\$34.69

FUEL DISTRIBUTION BLOCK

Two styles to choose from straight and "Y" for various applications. Straight unit features filter screen. Both feature 1/8" NPT outlet for fuel pressure gauge.



Style A: Bare Aluminum

Style B: Blue Anodized

PART #	STYLE	# OF OUTLETS	INLET THD. SIZE	OUTLET THD. SIZE	PRICE
100177	B	4	8 AN	1/4" NPT	\$11.48
100178	B	4	3/8" NPT	1/4" NPT	\$11.48
100179	A	2	3/8" NPT	1/4" NPT	\$19.15
100180	B	2	3/8" NPT	1/4" NPT	\$10.34
100181	A	2	3/8" NPT	6 AN MALE	\$24.44
100182	B	2	1/4" NPT	1/4" NPT	\$10.34

CARBURETOR & FUEL PUMP ADAPTERS

These specialty aluminum adapter fittings simplify the connection of AN hose assemblies to carburetors, power steering or fuel pumps.



PART #	CARB THD. SIZE	HOSE END SIZE	RECOMMENDED APPLICATION	PRICE
991941	5/8"-20	6	CARTER	\$6.53
991942	9/16"-24	6	SINGLE INLET HOLLEY	\$6.53
991943	7/8"-20	6	DUAL FEED HOLLEY	\$8.38
991944	12mm X 1.50	6	WEBER (IDA & DCOE)	\$6.53
991945	12mm X 1.25	6	DELLORTO/SOLEX	\$6.53
991946	1/2"-20	6	POWER STEERING/FUEL PUMP	\$6.53
991947	5/8"-18	6	POWER STEERING/FUEL PUMP	\$6.53
991948	7/8"-20	8	DUAL FEED HOLLEY	\$8.38
991949	7/8"-20	6	ROCHESTER	\$8.38
991950	11/16"-16	6	POWER STEERING	\$6.53
991951	7mm BANJO BOLT	6	DELLORTO	\$6.53
991952	1"-20	6	ROCHESTER 75 UP	\$8.38
991953	10mm X 1.00	6	WEBER (IDF)	\$8.38
991954	14mm X 1.50	6	POWER STEERING	\$7.67
991955	16mm X 1.50	6	POWER STEERING	\$7.67

INLINE FUEL FILTERS

Easily disassembled for inspection and cleaning, features 35 micron sintered bronze element.



PART #	FITTING SIZE	PRICE
230106	6	\$31.68
230108	8	\$40.09
230107	REPL ELEMENT	\$9.22

SCREEN TYPE IN-LINE FUEL AND OIL FILTERS

These disc type screen filters are perfect for pre-filter applications.

FUEL			OIL		
PART #	FITTING SIZE	PRICE	PART #	FITTING SIZE	PRICE
230204	4	\$31.68	230304	4	\$31.68
230206	6	\$31.68	230306	6	\$31.68
230208	8	\$40.09	230308	8	\$40.09
230210	10	\$40.09	230310	10	\$40.09
230212	12	\$48.40	230312	12	\$48.40
230216	16	\$62.66	230316	16	\$62.66



FUEL TIP OVER VALVE

An excellent safety device that can be installed in any fuel cell or tank. Serving as a non-restrictive vent, this tip over valve check ball closes on a rollover to prevent fuel from escaping.



PART #	DESCRIPTION	PRICE
834-008-11	#8 AN MALE THD.	\$19.95

PRESSURE GAUGE ADAPTERS

Each adapter has a female 1/8" NPT thread in the hex to accept a pressure gauge or adapter fitting.



PART #	DESCRIPTION	PRICE
100192	6 MALE TO 6 MALE WITH 1/8" NPT IN HEX	\$10.02
100193	6 MALE TO 1/4" NPT WITH 1/8" NPT IN HEX	\$10.02
100194	6 MALE TO 3/8" NPT WITH 1/8" NPT IN HEX	\$10.02
100196	8 MALE TO 8 MALE WITH 1/8" NPT IN HEX	\$11.65
100197	8 MALE TO 1/4" NPT WITH 1/8" NPT IN HEX	\$11.65
100198	8 MALE TO 3/8" NPT WITH 1/8" NPT IN HEX	\$11.65

LIQUID FILLED FUEL PRESSURE GAUGE

Now you can really know what your fuel pressure is at a glance, with this new easy to read 0-15 psi fuel pressure gauge. Liquid filled for vibration resistance. 1/8" NPT male thread is designed to fit on Pressure Gauge Adapter.



1-1/2" Body Dia.

PART #	DESCRIPTION	PRICE
100189	Fuel Gauge	\$36.76

OIL THERMOSTAT

To insure quick warm up under cold weather conditions, use our oil-stat. This uniquely designed product controls oil temperature like a thermostat controls water temperature in a radiator.



PART #	DESCRIPTION	PRICE
501	#10 AN FEMALE ON ALL PORTS	\$70.05

STAINLESS HARD LINE

This 304 stainless steel hard line is annealed making it very easy to bend and work with. Finished installation is sanitary, compact and durable. May be coupled to Speed Flex line when movement is required. Comes in 20' lengths, may be coiled or cut into 8' lengths + drop for UPS shipment. Sold by the foot.



PART #	OUTSIDE DIAMETER	WALL THICKNESS	PER FOOT PRICE
30-316-035*	3/16"	.035"	4.65
30-14-035	1/4"	.035"	1.54
30-38-035	3/8"	.035"	1.92
30-12-035	1/2"	.035"	4.68

*Seamless

ALUMINUM HARD LINE

Annealed aluminum tubing is easily formed for low-pressure applications (100# maximum, not for brake lines). Sold coiled in 10 ft. length, without anodized finish.



PART #	OUTSIDE DIA.	PRICE
100031	1/4"	\$8.23
100034	3/8"	\$9.93
100037	1/2"	\$13.03

HARD LINE ENDS

May be used with steel, stainless steel, or aluminum hard line, requires a single flare. See illustration for proper stack up.

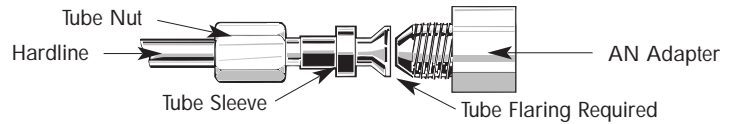

ALUMINUM TUBE NUT



PART #	QTY.	FTG.	SIZE	PRICE
581803	2	3	3/16"	\$2.51
581804	2	4	1/4"	\$2.51
581806	2	6	3/8"	\$2.51
981808	1	8	1/2"	\$1.94
981810	1	10	5/8"	\$2.86
981812	1	12	3/4"	\$3.74
981816	1	16	1"	\$6.28

ALUMINUM TUBE SLEEVE



PART #	QTY.	FTG.	SIZE	PRICE
581903	2	3	3/16"	\$2.11
581904	2	4	1/4"	\$2.11
581906	2	6	3/8"	\$2.11
981908	1	8	1/2"	\$1.38
981910	1	10	5/8"	\$1.55
981912	1	12	3/4"	\$2.86
981916	1	16	1"	\$4.24

STEEL TUBE NUT



PART #	QTY.	FTG.	PRICE
561803	2	3	\$3.35
561804	2	4	\$3.35

STEEL TUBE SLEEVE



PART #	QTY.	FTG.	PRICE
561903	2	3	\$2.51
561904	2	4	\$2.51

SPEED FLEX HOSE

The stiffness of the Teflon liner, combined with the resistance of the stainless steel braided outer cover dramatically reduces brake line expansion under pressure. This results in a much firmer and more controlled brake pedal. Applicable for medium pressure hydraulic systems, flexible brake and clutch, or instrument lines where extreme pressure is necessary. The continuous operation temperature range is -65° to +450° F.



PART #	SIZE	I.D.	OP. PRESSURE	PRICE
600003	3	.125 (1/8")	2000 PSI	\$3.35
600004	4	.190 (3/16")	2000 PSI	\$3.98

SPEED FLEX PRE-ASSEMBLED HOSE

Saves time and money! Earl's factory assembled hoses made from Speed Flex Teflon Hose, ideal for brake, clutch, instrument and injection hoses. Each hose is pressure tested to 4,000 psi. Maximum operating pressure: 2,000 psi. Hoses listed are #3 with #3 AN female swivel on both ends and #4 hose with #4 AN female swivel on both ends.



LENGTH	#3 HOSE		#4 HOSE	
	PART #	PRICE	PART #	PRICE
10"	63010110	\$11.37	N/A	N/A
12"	63010112	\$12.01	64191912	\$12.47
14"	63010114	\$12.64	N/A	N/A
16"	63010116	\$13.11	64191916	\$13.67
18"	63010118	\$13.67	N/A	N/A
20"	63010120	\$14.31	64191920	\$15.02
22"	63010122	\$14.94	N/A	N/A
24"	63010124	\$15.50	64191924	\$16.14
26"	63010126	\$16.14	N/A	N/A
28"	63010128	\$16.70	N/A	N/A
32"	63010132	\$17.88	64191932	\$18.76
36"	63010136	\$19.15	64191936	\$19.95
40"	63010140	\$20.27	N/A	N/A
44"	63010144	\$21.54	N/A	N/A
48"	63010148	\$22.74	N/A	N/A

STEEL SPEED SEAL HOSE ENDS

Construction: Specifically designed for use with Speed-Flex hose only, forming a positive leak resistant seal. Do not attempt to use fittings designed for use with other types of hose on Speed-Flex.

STRAIGHT



PART #	HOSE END SIZE	NUT SIZE	PRICE
600103	3	3	\$7.07
600104	4	4	\$7.07
600143	3	4	\$7.52

45° BENT TUBE



PART #	HOSE END SIZE	PRICE
604603	3	\$11.33
604604	4	\$11.33

90° BENT TUBE



PART #	HOSE END SIZE	PRICE
609103	3	\$11.33
609104	4	\$11.33

90° LOW PROFILE

PART #	HOSE END SIZE	PRICE
609003	3	\$20.03
609004	4	\$20.03



BRASS OLIVES



PART #	SIZE	PRICE
699030	3	\$1.23
699040	4	\$1.23

TEE



REF	PART #	FITTING SIZE	MOUNT HOLE SIZE	PRICE
A	6453003	3	#10 OR 3/16"	\$41.72
B	6453103	3	-	\$41.72
C	6453203	3	#10 OR 3/16"	\$41.72
D	6453503	3	-	\$41.72

HOSE END WITH ADAPTER



REF	PART #	HOSE END SIZE	THREAD SIZE	PRICE
A	640203	3	3/8-24 BULKHEAD MALE	\$8.38
B	640503	3	3/8-24 FEMALE I.F.	\$10.42
B	640603	3	10MM X 1.0 FEMALE I.F.	\$10.42

STRAIGHT BANJO



REF	PART #	HOSE END SIZE	BANJO BOLT SIZE	PRICE
A	600303	3	10mm or 3/8"	\$7.52
B	600703	3	10mm or 3/8"	\$7.52

BENT BANJO



REF	PART #	ANGLE	HOSE END SIZE	BANJO BOLT SIZE	PRICE
A	601503	90	3	10 MM OR 3/8"	\$11.65
B	600803	30	3	10 MM OR 3/8"	\$8.86
C	601103	20	3	10 MM OR 3/8"	\$8.86

BANJO BOLT



PART #	THD. SIZE	PRICE
977503	3/8"-24 SINGLE	\$4.56
977504	7/16"-20 SINGLE	\$4.56
977513	3/8"-24 DOUBLE	\$5.52
977517	10mm X 1.0 SINGLE	\$4.56
977520	10mm X 1.5 SINGLE	\$4.56

CRUSH WASHERS



PART #	PKG. QTY.	FITTING SIZE	HOLE I.D.	PRICE
177003	10	3	3/8"	5.29
177004	10	4	7/16"	5.29
177006	10	6	9/16"	5.29
177008	5	8	3/4"	5.29
177010	5	10	7/8"	5.29
177012	5	12	1-1/16"	5.29

BANJO ADAPTER



PART #	HOLE SIZE	THD. SIZE	PRICE
997603	3/8"	3 AN	\$7.84
997604	7/16"	4 AN	\$7.84
997634	7/16"	3 AN	\$7.84
997643	3/8"	4 AN	\$7.84

STEEL ADAPTERS

PIPE TO AN ADAPTERS

STRAIGHT

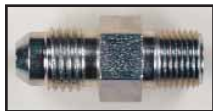

PART #	FITTING	PIPE THD.	PRICE
	SIZE	SIZE	
961603	3	1/8"	\$1.63
961604	4	1/8"	\$1.63

45°



PART #	FITTING	PIPE THD.	PRICE
	SIZE	SIZE	
962303	3	1/8"	\$8.06
962304	4	1/8"	\$4.56

90°



PART #	FITTING	PIPE THD.	PRICE
	SIZE	SIZE	
962203	3	1/8"	\$6.92
962204	4	1/8"	\$4.49

TEE PIPE THREAD ON SIDE



PART #	FITTING	PIPE THD.	PRICE
	SIZE	SIZE	
962503	3	1/8"	\$20.55
962504	4	1/8"	\$5.89

TEE PIPE THREAD ON RUN



PART #	FITTING	PIPE THD.	PRICE
	SIZE	SIZE	
962603	3	1/8"	\$19.32
962604	4	1/8"	\$5.89

FEMALE TEE



PART #	DESCRIPTION	PRICE
961701	1/8" NPT FEMALE	\$5.68

BRASS TEE



PART #	DESCRIPTION	PRICE
972050	ALL SIDES, 3/8-24 IF	\$12.57

LINE ADAPTER



PART #	THREAD SIZE	PRICE
989534	-3 AN TO FEM. 10MM X 1.0	\$4.88
989545	-3 AN TO FEM 10MM X 1.0 IF	\$4.88
989536	-3 AN TO FEM. 10MM X 1.25	\$4.88
989531	-3 AN TO 3/8-24 FEM	\$4.88
989543	-3 AN TO 3/8-24 FEM IF	\$4.88
989549	-3 AN TO 7/16-24 IF	\$4.88
989542	-4 TO FEM. 10MM X 1.0	\$4.88
989547	-4 AN TO FEM 10MM X 1.25 IF	\$4.88
989532	-4 TO 3/8-24 FEM.	\$4.88
989548	-4 AN TO 7/16-24 IF	\$4.88

GAUGE FITTINGS

May be used for gauges or hydraulic systems.



PART #	FIG. SIZE	DESCRIPTION	PRICE
968604	4	90° MALE 4 AN TO FEMALE 1/8" NPT	\$4.49
968704	4	STRAIGHT MALE 4 AN TO FEMALE 1/8" NPT	\$2.26
968603	3	90° MALE 3 AN TO FEMALE 1/8" NPT	\$6.53
968703	3	STRAIGHT MALE 3 AN TO FEMALE 1/8" NPT	\$2.19

PIPE NIPPLE



PART #	PIPE THD	PIPE THD	PRICE
901102	1/8	1/8	\$1.23
901104	1/4	1/4	\$1.55
901106	3/8	3/8	\$1.55
901108	1/2	1/2	\$2.34
901112	3/4	3/4	\$4.56
901113	3/4	1/2	\$5.37
901142	1/4	1/8	\$1.55
901162	3/8	1/8	\$3.10
901164	3/8	1/4	\$1.55
901184	1/2	1/4	\$2.02
901186	1/2	3/8	\$2.34

SPECIAL ADAPTERS



2 pcs per pkg

PART #	DESCRIPTION	PRICE
592032	-3 AN TO 10MM X 1.0, STEEL	\$10.02
592035	-3 AN TO 10MM X 1.25 IF, STEEL	\$10.02
581531	-3 AN TO 3/8-24 IF, STEEL	\$8.38
592046	-3 AN TO 1/2-20 IF, ALUM	\$10.02
592048	-3 AN TO 9/16-28 IF, ALUM	\$10.02
592042	-4 AN TO 10MM X 1.0, STEEL	\$10.02
592045	-4 AN TO 10MM X 1.25, STEEL	\$10.02
591972	-4 AN TO 3/8-24 IF, STEEL	\$10.02
591941	-4 AN TO 7/16-20 IF, STEEL	\$10.02
591942	-4 AN TO 7/16-24 IF, STEEL	\$10.02
592047	-4 AN TO 1/2-20 IF, ALUM	\$10.02
592049	-4 AN TO 9/16-18 IF, ALUM	\$10.02

**AN TO AN ADAPTERS
UNION MALE**

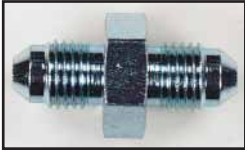

PART #	FTG.	
	SIZE	PRICE
961503	3	\$3.42
961504	4	\$2.26

TEE



PART #	FTG. SIZE	
	SIZE	PRICE
962403	3	\$19.32
962404	4	\$5.89

BULKHEAD NUT



PART #	FTG.		QTY.	PRICE
	SIZE			
502403	3	2	\$4.97	
502404	4	2	\$4.97	

BULKHEAD UNION



PART #	FTG. SIZE	PRICE
963243	3 AN LONG TO 4 AN SHORT	\$4.49
963203	3	\$4.49
963204	4	\$5.89

45° BULKHEAD UNION



PART #	FTG.	
	SIZE	PRICE
963703	3	\$24.12
963704	4	\$11.48

90° BULKHEAD UNION



PART #	FTG.	
	SIZE	PRICE
963303	3	\$24.12
963304	4	\$6.84

TEE BULKHEAD ON SIDE



PART #	FTG.	
	SIZE	PRICE
963403	3	\$29.00
963404	4	\$11.48

TEE BULKHEAD ON RUN



PART #	FTG.	
	SIZE	PRICE
960403	3	\$26.07
960404	4	\$26.07

90° WITH SWIVEL NUT



PART #	FTG.	
	SIZE	PRICE
966303	3	\$11.48
966304	4	\$5.89

BRAID SEPARATOR TOOL

In order to insert the "olive" into Speed-Flex Hose, the stainless protective braid must be separated from the teflon liner. This can be more difficult than it sounds. Earl's braid spreader solves the problem and eliminates the tiresome probability of poking holes in your fingers. In use, the tool is simply inserted into the cut end of the hose and pushed, spreading the braid. The olive is then placed on the tool mandrel, pushed over the hose liner, and under the braid until the liner bottoms against the shoulder of the olive. The tool mandrel is double-ended; one for -3 hose and one for -4. The handle contains a recess for storage of spare olives.

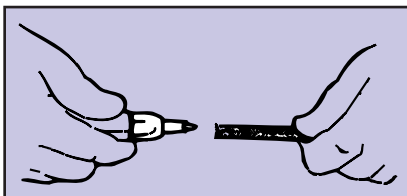

PART #	DESCRIPTION	PRICE
007	BRAID SEPARATOR TOOL	\$22.96



THREAD SIZES

For your convenience we have included the actual size silhouettes and related sizing information to assist in selecting the correct fitting for your plumbing application.

"AN" THREAD SIZES

"AN" (Army-Navy) Sizes were established by the Aerospace industry years ago and were designated O.D. of the rigid metal tube that each size fitting is used with. (The chart to the right will clarify this point).

The numbers assigned equate to the O.D. (outside diameters) of the tubing in 1/16". Since tubing and hoses are to be found with assorted wall thicknesses, we can now understand that the designated size number does not necessarily tell you how large the inside diameter will be. (For example, the inside diameter of an Earl's size 6 hose end is nearly as large as the inside diameter of some other manufacturers' -8 hose ends).

Each AN size number has its own standard thread size which can be seen in column three of the chart. Again, these are the same thread sizes that have been used in aircraft and industrial applications for many years.

AN SIZE	METAL TUBE O.D.	THREAD SIZE
2	1/8"	5/16-24 SAE
3	3/16"	3/8-24 SAE
4	1/4"	7/16-20 SAE
5	5/16"	1/2-20 SAE
6	3/8"	9/16-18 SAE
8	1/2"	3/4-16 SAE
10	5/8"	7/8-14 SAE
12	3/4"	1-1/16-12 SAE
16	1"	1-5/16-12 SAE
20	1-1/4"	1-5/8-12 SAE
24	1-1/2"	1-7/8-12 SAE
28	1-3/4"	2-1/4-12 SAE
32	2"	2-1/2-12 SAE

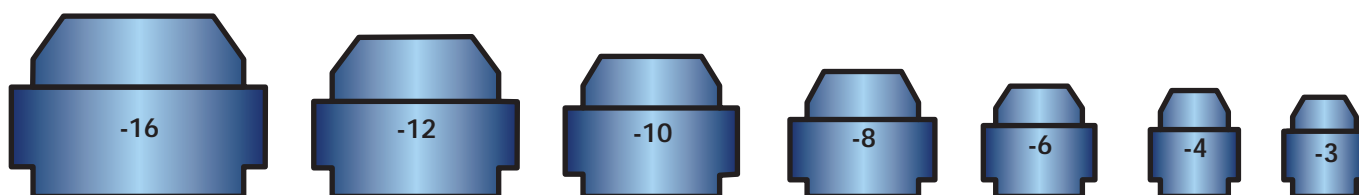

"NPT" THREAD SIZES

WE CAN NOW LEAVE AN thread sizing and head on to the next category which is N.P.T. (National Pipe Threads). National Pipe Threads are the next most popular thread size used in "Competition Plumbing". We can actually find a resemblance between the size call outs and the I.D. (inside diameter) of the fitting. The outside silhouettes shown here will help verify your fitting selection.

PIPE THREAD SIZE	THREADS PER INCH	THEORETICAL I.D. OF FTG.	CLOSEST AN FTG. SIZE
1/16"	27	1/16"	-
1/8"	27	1/8"	4
1/4"	18	1/4"	6
3/8"	18	3/8"	8
1/2"	14	1/2"	10
3/4"	14	3/4"	12
1"	11-1/2	1"	16
1-1/4"	11-1/2	1-1/4"	20
1-1/2"	11-1/2	1-1/2"	24
2"	11-1/2	2"	32

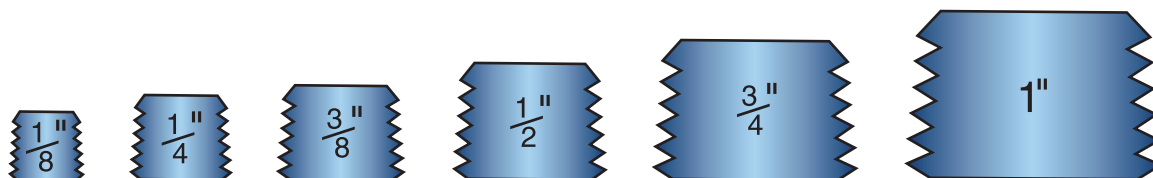

PERFORM-O-FLEX HOSE WITH SWIVEL SEAL HOSE ENDS

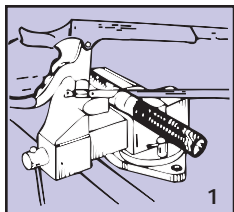

1. Cut hose to required length.

a. Measure distance between parts of adapter fittings along the path that the hose run will follow - allowing for bend radius, hose end length and offset to obtain length and hose required.

b. Cut the hose square with a radiac wheel or a sharp 32 teeth per inch hacksaw blade. It is necessary to wrap it tightly with masking tape before cutting and to cut through the tape. This helps to prevent the stainless wire braid from fraying.

c. Trim any frayed end of the braid with a sharp pair of metal snips or diagonal cutters and remove the tape.

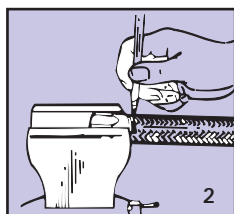

2. Place the socket in a vise and insert the end of the hose into the socket until the hose butts against the bottom of the threads provided for the cutter. Gently pull the hose back until there is a 1/16" to 1/8" gap between the end of the hose and the bottom of the socket - mark hose at bottom of socket with a felt pen so that you can detect any tendency of the hose to be pushed out as you complete the assembly.

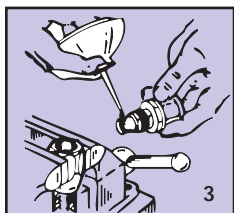

3. Lubricate the inside of the hose, the cutter threads and the socket threads. Just about any kind of clean oil will do but we prefer to use an anti-seize compound on the threads. Place the nipple in a vise. Flex muscles.

4. Push the hose and the socket onto the nipple until the socket threads can be started on the cutter. Start the threads and go as far as you can by hand. Depending on the size of the hose, some force may be necessary in this part of the operation.

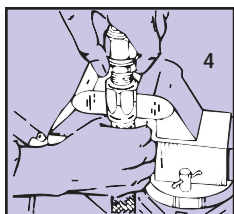

5. To complete the assembly it doesn't matter whether the nipple or the socket is held in the vise. Holding one or the other in the vise and using a suitable wrench on the other, tighten the socket onto the cutter threads until the socket is within .060" of bottoming on the nipple. Do not use an adjustable or over-size wrench or you will damage either the nipple or the socket.

6. Check the mark that you made on the hose in step 2. If the hose has backed more than about 1/16" out of the socket as you assembled it, curse and return to step 3.

7. Clean the hose and the hose ends with CLEAN solvent.

8. It is most unlikely that you will have available any method of pressure checking the assembly before it is installed. Before letting the assembly out of your sight, check the assembly by running the system at full pressure while you observe the hose, hose ends and adapters for leaks.

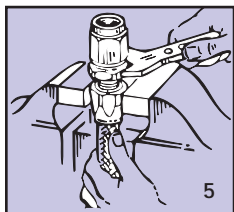

SPEED FLEX HOSE WITH SPEED SEAL HOSE ENDS

Brake lines are critical items. The potential penalties for improper assembly are severe. Although there is nothing complicated about the procedure and no special tools are required, extreme care must be used in assembly. We strongly recommend that the following procedures be used.

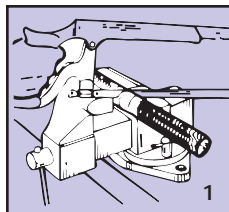

1. Cut the hose to the required length. We recommend the use of a radiac wheel but it can be done satisfactorily with a 32 teeth per inch hacksaw blade. In either case, the hose must be tightly wrapped with masking tape and the cut made through the tape. Do not cut Speed Flex hose with a chisel, snips, pliers, or a shear as these may crush the teflon sleeve.

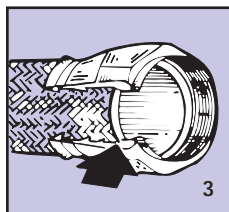

2. Deburr the Teflon and trim any loose ends of braid with sharp snips or diagonal cutting pliers, and remove tape.

3. Install the socket on the hose with the threaded end of the socket toward the cut end of the hose. This will be a lot easier and you will end up with fewer holes in your hand if you clamp the socket in a vise. Push socket on well beyond end.

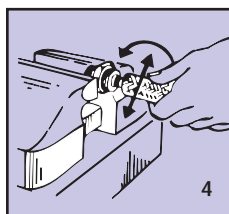

4. Place the hex portion of the nipple in the vise. Insert the end of the hose onto the nipple and bottom the hose against the chamfer seat of the nipple with a rotary motion of the hose. This will size the I.D. of the Teflon tube and start the necessary separation of the tube from the braid.

5. Separate the braid from the O.D. of the Teflon Tube with a small screwdriver or a scribe. Be careful not to scratch or nick the Teflon.

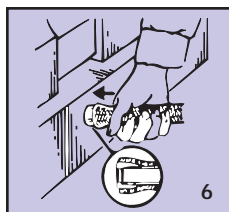

6. Install the sleeve between the braid and the Teflon tube. Make sure that none of the braid is trapped between the Teflon and the sleeve. Bottom the tube against the shoulder of the sleeve and make sure that the sleeve is inserted square.

7. With the nipple held in the vise push the hose and the sleeve onto the nipple until the sleeve bottoms. Remove the hose and make sure that the Teflon tube is still bottomed against the shoulder of the sleeve and that the sleeve is still square.

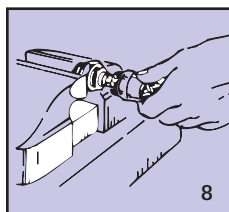

8. Push the hose and sleeve back onto the nipple and bottom against the chamfer. Start the socket onto the nipple threads and hand tighten.

9. Place the socket in the vise and complete the assembly by tightening the nipple onto the socket with a wrench until the gap between the face of the socket and the hex of the nipple is .023" to .046" - use a feeler gauge.

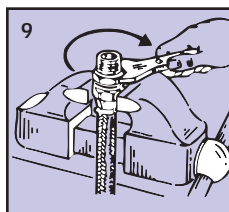

10. Blow the assembly clean and pressure test before running the car.



books & clothing

Want to be an expert mechanic? Or maybe you're looking for something to wear to next weekend's race? Well, we've got the variety of books and clothing you need. These books will help you learn the special technical tips that will make

your work perform better and they will prove to be an important reference tool in the future. Also, the assortment of quality Chassis Shop apparel, decals, and banners keeps you looking stylish.

MANUALS



How to build structurally sound, good-looking metal parts for custom street rods, race cars or restorations. Over 350 step-by-step photos and instructions illustrate welding, metal shaping and design techniques.

PART #	DESCRIPTION	PRICE
C80-022	METAL FAB HANDBOOK	\$17.95

How to select and install the correct turbo for 50% to 300% high-performance improvement. "Everything you could possibly need to know about turbochargers for automotive applications is in this book." -POPULAR CARS

PART #	DESCRIPTION	PRICE
C80-031	TURBOCHARGERS	\$17.95

Absolutely the most complete book on door slammer chassis science ever written. Chapters include Chassis Theory, Chassis Structure, Shocks and Springs, Front Suspension, Rear Suspension, Brake Systems, along with Tires and Testing. A must for every serious racer or auto enthusiast.

PART #	DESCRIPTION	PRICE
C80-010	DOOR SLAMMERS	\$29.95

Contains innovative instructions for all types of welding, particularly automotive, home repair, arts and crafts, as well as aviation. Practical projects and certification test procedures are included. Discusses processes, equipment, safety and techniques.

PART #	DESCRIPTION	PRICE
C80-021	WELDER'S HANDBOOK	\$17.95

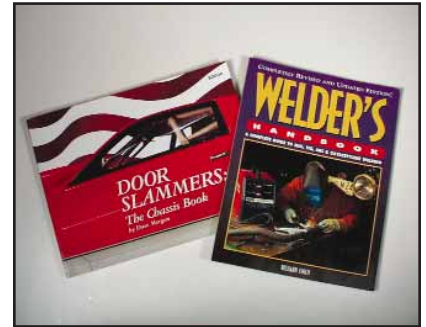

SPORTSWEAR

A. POLO SHIRT- WHITE

PART #	DESCRIPTION	PRICE
C97-130	SM WHITE POLO	\$32.95
C97-131	MED WHITE POLO	\$32.95
C97-132	LG WHITE POLO	\$32.95
C97-133	XLG WHITE POLO	\$32.95
C97-134	XXLG WHITE POLO	\$34.95



B. SWEATSHIRT- BLACK

PART #	DESCRIPTION	PRICE
C97-151	MED BLACK SWEAT	\$20.95
C97-152	LG BLACK SWEAT	\$20.95
C97-153	XLG BLACK SWEAT	\$20.95
C97-154	XXLG BLACK SWEAT	\$22.95

C. T-SHIRT- RED

PART #	DESCRIPTION	PRICE
C97-110	SM RED TEE	\$16.95
C97-111	MED RED TEE	\$16.95
C97-112	LG RED TEE	\$16.95
C97-113	XLG RED TEE	\$16.95
C97-114	XXLG RED TEE	\$17.95



D. CAP- BLACK W/ RED TRIM

PART #	DESCRIPTION	PRICE
C97-105	CAP BLK W/ RED TRIM	\$12.95

E. DECALS

PART #	DESCRIPTION	PRICE
C97-100	SM DECAL	\$0.50
C97-101	LG DECAL	\$1.00



F. BANNER

PART #	DESCRIPTION	PRICE
C97-103	BANNER 18" X 54"	\$9.95

turbo

The Chassis Shop carries a full line of performance proven turbo system components for a wide variety of high-performance applications. This selection of precision, high output accessories are designed to greatly enhance horsepower and provide dependable,

consistent performance. Turbocharging has become the least expensive way to get more horsepower from an engine when compared to boring, stroking, and aftermarket cylinder heads.

HI-VELOCITY 4 BARREL MANIFOLD

A Chassis Shop original- flow bench developed, this volumetric efficient smooth radius design outflows cast aluminum manifolds by 10%. Hi-velocity eliminates fuel puddling resulting in a cleaner/leaner mixture, with improved throttle response. Lightweight sheet aluminum construction features quality tig welding and micro-polishing. The choice of many leading engine builders and record holders. Several sizes available for accurate sizing to turbo housing- no restrictive adapters required. Optional defrost tube may have warm water or oil circulated through to reduce condensation in cool or damp running.



PART #	INLET SIZE	CARB FLANGE	VERSION	PRICE
C76-140	2-3/4" OD	4 BARREL	STANDARD	\$209.95
C76-140-D	2-3/4" OD	4 BARREL	DEFROST TUBE	\$239.95
C76-141	2-3/4" OD	DOMINATOR	STANDARD	\$209.95
C76-141-D	2-3/4" OD	DOMINATOR	DEFROST TUBE	\$239.95
C76-142	3" OD	4 BARREL	STANDARD	\$209.95
C76-142-D	3" OD	4 BARREL	DEFROST TUBE	\$239.95
C76-143	3" OD	DOMINATOR	STANDARD	\$209.95
C76-143-D	3" OD	DOMINATOR	DEFROST TUBE	\$239.95
C76-144	4" OD	4 BARREL	STANDARD	\$209.95
C76-144-D	4" OD	4 BARREL	DEFROST TUBE	\$239.95
C76-145	4" OD	DOMINATOR	STANDARD	\$209.95
C76-145-D	4" OD	DOMINATOR	DEFROST TUBE	\$239.95



Optional Defrost Tube

HOSE COUPLING

Hi-quality, durable, temp resistant hose couplings have multi-layer construction with fiberglass reinforcement and measure 2" in length. We recommend the use of three hose clamps to prevent hose rupture.

PART #	SIZE	PRICE
C76-196	1-5/8" ID	\$9.95
C76-198	1-3/4" ID	\$9.95
C76-200	2" ID	\$9.95
C76-202	2-1/4" ID	\$9.95
C76-204	2-1/2" ID	\$9.95
C76-206	2-3/4" ID	\$9.95
C76-208	3" ID	\$9.95
C76-210	4" ID	\$12.95



TURBO CHARGER

The T-04B series turbocharger sets the standard for maximum horsepower efficiency. The broader operating range and superior air flow characteristics of these hybrid units make the Airesearch turbo the standard for championship applications. Each unit is assembled to order, individually sized to match engine displacement, RPM range and boost level.



PART #	INTAKE COMPRESSOR	EXHAUST TURBINE WHEEL	EXHAUST HOUSING	PRICE
10150-58	S3	N	0.58	\$691.19
10275-58	V	O	0.58	\$691.19
10275-69	V	O	0.69	\$691.19
10275-81	V	O	0.81	\$691.19
10327-58	V	P	0.58	\$691.19
10327-69	V	P	0.69	\$691.19
10327-81	V	P	0.81	\$691.19
10303-69	H3	O	0.69	\$691.19
10303-81	H3	O	0.81	\$691.19
10400-81	H3	P	0.81	\$691.19
10400-96	H3	P	0.96	\$691.19

	SIZING COMPARISON			
	SMALL	← →		LARGE
INTAKE COMPRESSOR	S3		V	H3
EXHAUST TURBINE WHEEL	N		O	P
EXHAUST HOUSING	.58	.69	.81	.96

TURBO DRAIN

Cast aluminum construction tapped 1/2" NPT. Fits all T-04 type turbos.



PART #	DESCRIPTION	PRICE
20259	DRAIN PLATE	\$11.58
30141	GASKET	\$1.28

TURBO GASKETS

Durable fiber-type gaskets cut to fit both Rayjay and T-04B Airesearch type turbos.

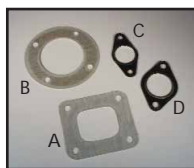

REF	PART #	DESCRIPTION	PRICE
A	C76-435	TURBO INLET	\$3.00
B	C76-436	TURBO OUTLET	\$3.00
C	C76-437	DELTA GATE	\$4.96
D	C76-439	RACE GATE	\$3.08

BLOW PROOF GASKETS

Positive sealing internal compression ring works excellently for turbo and aspirated applications. Can be reused, 1.550" I.D. Sold in packs of two.



PART #	DESCRIPTION	PRICE
C76-438-2	BLOW PROOF GASKETS	\$11.90

STEEL FLANGES

These heavy exhaust flanges are the same ones we use on our custom-built manifolding. Extra thick to prevent warpage. Laser cut accuracy for proper fit.



PART #	APPLICATION	THICKNESS	QTY	PRICE
C76-390-2	EXHAUST 2-BOLT VW 1-1/2" ID	3/8"	2	\$17.00
C76-391-2	EXHAUST 2-BOLT VW 1-5/8" ID	3/8"	2	\$17.00
C76-392-2	EXHAUST 2-BOLT VW 1-3/4" ID	3/8"	2	\$17.00
C76-430	TURBO INLET 4-BOLT SQUARE	5/16"	1	\$9.95
C76-431	TURBO OUTLET 4-BOLT ROUND	5/16"	1	\$9.95
C76-432-2	DELTA GATE INLET/OUTLET DRILLED HOLES	5/16"	2	\$17.90
C76-434-2	RACE GATE INLET/OUTLET DRILLED HOLES	5/16"	2	\$17.90

BLOW OFF VALVE

A must on all blow through turbo applications. The 1-5/8" dia. valve, with high volume oval porting, has proven effective in releasing turbo damaging excessive manifold pressure when throttle plate closes. CNC machined from lightweight billet aluminum, o-ring provides positive seal.



PART #	DESCRIPTION	PRICE
C76-150	BLOW OFF VALVE	\$179.95
C76-158	STEEL WELD-ON FLANGE	\$8.95
C76-159	ALUM WELD-ON FLANGE	\$8.95

DELTA GATE WASTEGATE

Positive boost control for all turbocharged applications. The most efficient wastegate available. A large 4-1/2" diameter diaphragm provides surge proof control of the 1-1/4" dia. taper seated valve. Mechanically adjustable to a maximum of 13#. For higher boost levels, a dial-a-boost is necessary. (See Pg. 117).



PART #	DESCRIPTION	PRICE
C76-170	DELTA GATE	\$219.82
C76-437	DELTA GATE GASKET	\$4.96
C76-432-2*	DELTA GATE FLANGE INLET/OUTLET DRILLED HOLES 5/16" THICK	\$17.90

*Sold in packs of 2

RACE GATE WASTEGATE

Features same quality construction incorporated in Delta gate but with a larger 1-5/8" dia. valve. Flowing 65% more, this unit is a favorable alternative for heavy breathing applications that would normally require two Delta gates.



PART #	DESCRIPTION	PRICE
C76-171	RACE GATE	\$373.58
C76-439	RACE GATE GASKET	\$3.08
C76-434-2*	RACE GATE FLANGE INLET/OUTLET DRILLED HOLES 5/16" THICK	\$17.90

* Sold in packs of 2

TURBO REPLACEMENT PARTS

We stock every part necessary to repair or update the T04-B style turbos. There are many sizes of housings available for optimum performance tuning.

PART #	DESCRIPTION	PRICE
20202	COMPRESSOR HOUSING, S-3	\$108.86
20203	COMPRESSOR HOUSING, V-1	\$108.86
20192	COMPRESSOR HOUSING, H-3	\$108.86
30229	O-RING (ALL COMPRESSOR HOUSINGS)	\$6.70
20193	COMPRESSOR HOUSING CLAMP PLATE	\$0.72
20207	FLANGE BOLT COMPRESSOR HOUSING, 5/16-18 NC	\$0.86
20330	COMPRESSOR WHEEL, S-3	\$100.21
20325	COMPRESSOR WHEEL, V-1	\$100.21
20235	COMPRESSOR WHEEL, H-3	\$100.67
20301	TURBINE WHEEL & SHAFT, N	\$161.65
20302	TURBINE WHEEL & SHAFT, O	\$161.65
20303	TURBINE WHEEL & SHAFT, P	\$161.65
20297	TURBINE WHEEL SHROUD	\$26.37
30233	LOCK NUT FOR TURBINE SHAFT, 1/4-28 RH	\$3.29
20440	STAGGER GAP OIL SEAL FOR SHAFT	\$19.75
20258-1	TURBINE HOUSING, N .58 A/R	\$182.56
20269-1	TURBINE HOUSING, N .69 A/R	\$182.56
20258-2	TURBINE HOUSING, O .58 A/R	\$182.56
20269-2	TURBINE HOUSING, O .69 A/R	\$182.56
20281-2	TURBINE HOUSING, O .81 A/R	\$182.56
20296-2	TURBINE HOUSING, O .96 A/R	\$182.56
20269-3	TURBINE HOUSING, P .69 A/R	\$182.56
20281-3	TURBINE HOUSING, P .81 A/R	\$182.56
20296-3	TURBINE HOUSING, P .96 A/R	\$182.56
20237	TURBINE HOUSING, P 1.30 A/R	\$196.18
20194	TURBINE HOUSING CLAMP PLATE (2-BOLT)	\$1.21
20195	TURBINE HOUSING CLAMP PLATE (3-BOLT)	\$1.42
20209	EXHAUST HOUSING BOLT, 5/16-18 NC	\$0.52
20256-0	SHAFT BEARING, STD OD X STD I.D.	\$6.39
20256-4	SHAFT BEARING, +.010" OD X -.010" I.D.	\$7.06
20256-6	SHAFT BEARING, +.010" OD X STD I.D.	\$7.06
30235	RETAINING RING FOR SHAFT BEARING	\$0.34
20291	THRUST BEARING	\$13.81
20275	THRUST SPACER	\$9.22
20262	THRUST COLLAR	\$20.59
30209	CARBON DYNAMIC SEAL ASSEMBLY	\$19.46
20304	RING SEAL, CENTER SECTION TO BACK PLATE	\$1.19



turbo

DIAL-A-BOOST

Alters wastegate setting without mechanical adjustment, allows infinite control of boost pressure and may be mounted in cockpit. Lightweight leak-proof construction is not affected by moisture or dirt. Compatible with most wastegates.

PART #	DESCRIPTION	PRICE
C76-172	DIAL-A-BOOST	\$29.95
C76-174	REMOTE MOUNT PLATE & NUT	\$9.12



TURBO "T" CENTER SECTION

Smooth radius bends into these "T" center sections results in reduced friction, lower intake temperatures- higher thermal efficiency. The bottom line is more horsepower with less chance of detonation.

PART #	INLET SIZE	OUTLET SIZE	PRICE
C36-120	2" DIA.	1-5/8" DIA.	\$64.95
C36-121	2" DIA.	1-3/4" DIA.	\$64.95
C36-122	2" DIA.	2" DIA.	\$64.95
C36-123	2" DIA.	2-1/4" DIA.	\$64.95
C36-125	2-1/4" DIA.	1-5/8" DIA.	\$64.95
C36-126	2-1/4" DIA.	1-3/4" DIA.	\$64.95
C36-127	2-1/4" DIA.	2" DIA.	\$64.95
C36-128	2-1/4" DIA.	2-1/4" DIA.	\$64.95
C36-129	2-1/2" DIA.	2" DIA.	\$64.95
C36-130	2-1/2" DIA.	2-1/4" DIA.	\$64.95

2" fits Airesearch, 2-1/4" fits Rayjay,
2-1/2" fits 60 series Turbos

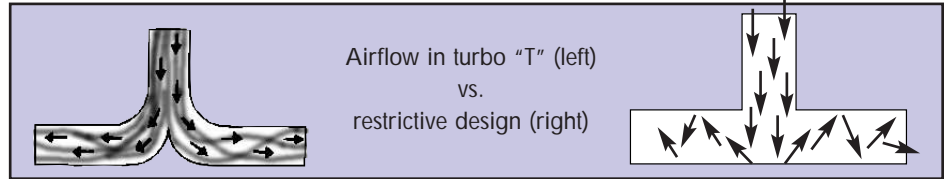

MULTIPLE DISC CLUTCH

If you're making good horsepower and are tired of slipping it away or using one of those bend-all, tranny smasher pressure plates... this is your answer. Proven with service in off-road, drag race and dune buggies. This bolt-on package includes special formed steel pressure plate, semi-metallic 3-pad discs, floater plate, release bearing and labor to modify your flywheel. Our clutch may be installed in dowel pinned, wedge mated, flanged, Type IV and most adapter type flywheels. Requires late style throw-out bearing shaft with "candlestick" style bearing support.



PART #	DESCRIPTION	PRICE
C35-001	COMPLETE CLUTCH KIT, VW SPLINE	\$499.95
C35-002	COMPLETE CLUTCH KIT, 1-1/8-10 (CHEVY) SPLINE	\$499.95

REPLACEMENT PARTS

PART #	DESCRIPTION	PRICE
C35-010	T/O BEARING	\$34.95
C35-007	VW SPLINED CLUTCH DISC	\$69.95
C35-008	1-1/8-10 (CHEVY) SPLINE CLUTCH DISC	\$69.95
C35-006	FLOATER PLATE	\$69.95
C35-005	PRESSURE PLATE	\$143.55
	MACHINING TO FLYWHEEL	\$125.00
	ADDITIONAL LIGHTENING TO FLYWHEEL	\$75.00
	FLYWHEEL CORE VALUE	\$75.00

AUTO ADAPTER PLATE

This aluminum plate adapts Chevy Powerglide, Turbo 350 or 400 transmission to a VW air cooled engine. Includes transmission dowel pins to ensure accurate alignment. Measures 1/4" thick x 18-1/2" tall x 20" wide.

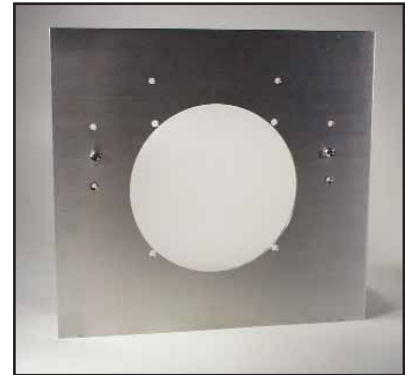

PART #	DESCRIPTION	PRICE
C12-300	AUTO ADPT PLATE	\$145.95

CRANK ADAPTER HUB

Adapts standard GM style flex plate to the end of a 8-dowel pin style VW crankshaft.



PART #	DESCRIPTION	PRICE
C12-301	8 DOWEL PIN HUB	\$169.95



Date: _____

Customer # _____

NAME: _____

BILL TO: ADDRESS: _____ CITY: _____ STATE: _____

ZIP CODE: _____ PHONE: () _____

NAME: _____

SHIP TO: ADDRESS: _____ CITY: _____ STATE: _____

ZIP CODE: _____ PHONE: () _____

METHOD OF PAYMENT:

COD (Certified CK or Money Order) CARD NUMBER: _____
 Bankcard (VISA, MC, DISC, or AM EXP) EXP. DATE: _____
 Prepaid (Certified CK or Money Order) NAME ON CARD: _____

METHOD OF SHIPMENT: UPS GROUND UPS NEXT DAY (RED) UPS SECOND DAY (BLUE)
 UPS THIRD DAY (ORANGE) TRUCK

PART NO.	DESCRIPTION	QTY.	PRICE	TOTAL
NOTE: MICHIGAN RESIDENTS ADD 6% SALES TAX			SUB TOTAL	
CALL FOR APPROX. SHIPPING EXPENSE FOR PRE-PAID ORDERS			TAX	
ON PRE-PAID ORDERS THAT INCLUDE INSUFFICIENT PAYMENT			SHIPPING	
THE BALANCE WILL BE SENT C.O.D.			TOTAL	

1931 N. 24th Ave. Mears, MI 49436
 Orders 1-800-530-9494 Tech (231) 873-3640 Fax (231) 873-0218
 www.ChassisShop.com

order form

Notes

A series of horizontal dashed lines for writing notes.

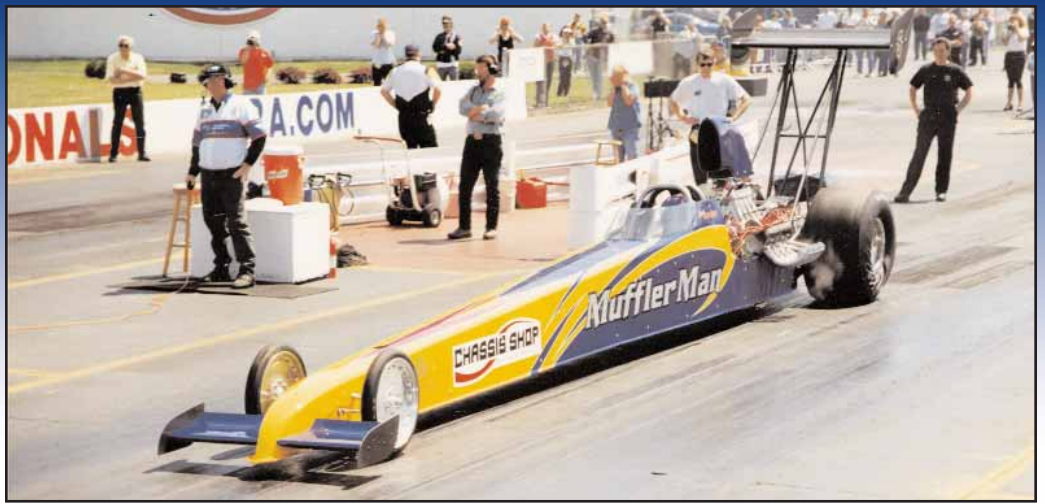

Shawn Bowen (Montrose, MI) in the Bowen Family Racing's NHRA nitro burning A/Fuel dragster.



Richard Montiel (Riverside, CA) in his top fuel record holding 100 yard sand dragster.

commitment & success



Experience

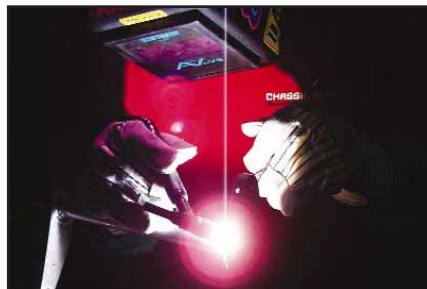

Skill



Technology

Moving into the 21st century requires a newer, higher level of technical prowess from manufacturer, builder, and racer. We've dedicated our engineering and manufacturing department to achieve the highest level of product performance. From sophisticated computer modeling to state-of-the-art CNC machining centers, our fabricated products are the best in the business.

TERMS: COD orders are accepted on a certified check or money order basis ONLY. If a COD delivery is refused we will require full prepayment for future orders. Certified checks or money orders are preferred to expedite clearance for prepaid orders. Orders not including adequate freight allowance will be sent COD for the balance. Any order under \$50.00 (excluding shipping & COD charges) will be charged an additional \$5.00 for processing.

CREDIT: No personal credit, we accept VISA, MASTERCARD, DISCOVER, and AMERICAN EXPRESS. Orders must be sent to the same name on the card.

DEPOSITS: A 50% deposit is required on custom built and special order merchandise, all deposits are non-refundable.

RETURNS: Return authorization required, 30-day limitation. All merchandise is subject to a 20% restocking fee and must accompany original invoice. No returns on custom built or special order merchandise.

DELIVERY: All merchandise will be shipped the fastest, most economical method, usually UPS Surface, unless you specify Red Label (overnight), Blue Label (2nd day), Orange Label (3 day), or another carrier such as Federal Express. Truck shipments require full prepayment.

CLAIMS: Damage claims must be made with freight carrier. Claims regarding content errors must be reported within 48 hours of receipt of order. Save all packaging for carrier inspection.

INTERNATIONAL ORDERS: Unless restricted by law, we will ship to international customers. Orders outside of the UPS COD shipping territory must include full prepayment with the necessary import/export documents. Orders requiring special or additional documentation will be charged accordingly.

PRICES: Every effort possible will be made to hold published prices. All prices are subject to change without notice. We cannot accept the responsibility for typographical errors in content or pricing.

SPECIFICATIONS: Non-critical specifications are subject to change without notice.

WARRANTY: Neither the seller nor the manufacturer will be liable for any loss, damage or injury directly or indirectly arising from the use or inability to determine the use of these products. Before using the user shall determine the suitability of the product(s) for its intended use and the user shall assume all responsibility and risk in connection therewith.

The CHASSIS SHOP PERFORMANCE PRODUCTS, INC. will, at its option, repair or replace any product(s) found to be defective due to workmanship or materials for a period of 12 months from the date of purchase. Merchandise should be returned to the CHASSIS SHOP freight prepaid and will be returned to the purchaser FOB Mears, MI.

CAUTION: Products in this catalog which alter your engine performance are "Legal in California Only for Racing Vehicles Which May Never Be Used Upon a Highway." And may not comply with requirements of other state/local laws regarding noise or emission levels.



1931 N. 24th Ave.
Mears, MI 49436

PRSR STD
U.S. POSTAGE
PAID
MEARS, MI
PERMIT NO.3

● Toll Free: 800-530-9494

● Tech Line: 231-873-3640

● Fax: 231-873-0218

● Web: www.ChassisShop.com